

**STANDARD SPECIFICATIONS
FOR
STREET IMPROVEMENTS**

JACKSON, MISSOURI



March, 2011

Engineering Department
Kent A. Peetz, P.E.
City Engineer
101 Court Street
Jackson, MO 63755
Phone: (573) 243-2300 Fax: (573) 243-3322
Email: kpeetz@jacksonmo.com

TABLE OF CONTENTS

100 GENERAL SPECIFICATIONS

101	General	1
102	Definition of Terms	1
103	Specifications	2
104	Interpretation of Plans and Specifications	2
105	Instructions	3
106	Inspection	3
107	Night and Sunday Work	3
108	Execution of the Work	4
109	Lines and Grades	4
110	Foreman	4
111	Materials, Labor, Tools, Etc.	5
112	Conduits in Streets, Manholes, Etc.	5
113	Protection to Finished Work	5
114	Provisions for Drainage and Traffic	5
115	Cleaning Up – Driveways	6
116	Extra Work and Change Orders	6
117	Engineer’s Measurements	6

200 DETAILED SPECIFICATIONS

201	General	7
202	Excavation Classification	8
202.1	Cuts and Fills	8
202.2	Borrow	9
202.3	Payment for Excavation	9
203	Subgrade and Base	11
203.1	Subgrade	11
203.1(a)	Subgrade Construction	11
203.1(b)	Disturbed Subgrade	11

203.1(c)	Subgrade Inspection	12
203.2	Density Tests	12
203.3	Aggregate Base Material	13
203.4	Aggregate Base Construction	13
204	Asphaltic Concrete Pavement	15
204.1	Plant Mix Bituminous Base	15
204.1(a)	Subgrade and Aggregate Base	15
204.1(b)	Transportation	15
204.1(c)	Spreading	15
204.1(d)	Leveling Course	16
204.1(e)	Joints	16
204.1(f)	Compaction	16
204.1(g)	Surface Tolerance	17
204.1(h)	Tolerance in Pavement Thickness	17
204.1(i)	Method of Measurement	18
204.1(j)	Basis of Payment	18
204.2	Asphaltic Concrete Surfacing	18
204.2(a)	Weather Limitations	18
204.2(b)	Subgrade Preparation	19
204.2(c)	Tack Coat	19
204.2(d)	Transportation	20
204.2(e)	Spreading	20
204.2(f)	Joints	21
204.2(g)	Surfaced Approaches	21
204.2(h)	Compaction	21
204.2(i)	Surface Tolerances	22
204.2(j)	Tolerances in Pavement Thickness	23
204.2(k)	Deficient Pavement on Private Projects	24
204.2(l)	Method of Measurement	24
204.2(m)	Basis of Payment	24
204.2(n)	Concrete Curb and Gutter	25

205	Portland Cement Concrete Pavement Slab	26
205.1	General	26
205.1(a)	Portland Cement Concrete Mix Designs	26
205.2	Cement	26
205.3	Consistency and Water-Cement Ratio	27
205.4	Air Entrainment	27
205.5	Proportions	28
205.6	Mixing	29
205.7	Central Mixed and Ready Mixed Concrete	29
205.8	Retempering	32
205.9	Record of Cement Used	32
205.10	Forms	32
205.11	Placing Concrete	32
	204.11(a) Cleanout and Washout Facilities	33
205.12	Slip Form Paver	33
205.13	Consolidation and Finishing	34
	205.13(a) Floating, Straightening, and Edging	35
	205.13(b) Final Surface Finish	35
205.14	Curing and Protection	35
	205.14(a) Liquid Curing Compound	36
	205.14(b) Wet Burlap or Cotton Mats	36
	205.14(c) Waterproof Plastic Sheets	37
205.15	Weather Conditions	37
	205.15(a) Cold Weather	37
	205.15(b) Rain and Inclement Weather	37
	205.15(c) Hot and/or Dry Weather	38
205.16	Reinforcing Steel Bars	39
205.17	Protection of Slab at Intersecting Streets	39
205.18	Opening to Traffic	39
205.19	Joint Construction	40
	205.19(a) Transverse and Expansion Joints	40

	205.19(b) Contraction Joints	40
	205.19(c) Construction Joints	41
	205.19(d) Longitudinal Joints	41
	205.19(e) Sealing Joints	42
	205.20 Payment for Concrete Pavement Slab	42
	205.21 Backfilling Slab Edges and Curbs	42
	205.22 Testing and Inspections	43
	205.22(a) Coring for Pavement	43
	205.23 Pavement Repair or Replacement	44
206	One Course Portland Cement Concrete Curb and Integral Curb	45
	206.1 General	45
	206.2 One Course P. C. Concrete Curb	45
	206.3 P. C. Integral Curb	45
	206.4 Payment for P. C. One Course Concrete Curb and Integral Curb	46
207	Miscellaneous Requirements Applicable to all Street Improvements	47
	207.1 General	47
	207.2 Payment for Miscellaneous Requirements	47
208	Portland Cement Concrete Sidewalk	48
	208.1 Description	48
	208.2 Materials	48
	208.3 Mixing Concrete	48
	208.4 Construction Methods	48
	208.5 Depositing Concrete	49
	208.6 Joints	49
	208.7 Curb and Sidewalk Ramps	49
	208.8 Detectable Warnings	50
	208.9 Curing	50
	208.10 Backfill	50
	208.11 Guarantee	50
	208.12 General Stipulations	50
300	Standard Drawings for Street Construction and Driveways	53

301	P.C.C. Street (Local-Residential)	54
302	P.C.C. Street (Collector)	55
303	P.C.C. Street (Commercial- Arterial)	56
304	Joint/Sawcut Location Plan	57
305	Construction and Expansion Joint Details	58
306	Asphaltic Street (Local-Residential)	59
307	Asphaltic Street (Collector)	60
308	Asphaltic Street (Commercial-Arterial)	61
311	Driveway Plan and Sectional Views	62
313	Concrete Street Repair Diagram	63
314	Street and Right of Way Standard Widths	64
315	Sidewalk Curb Ramp Standards	65
316	Sidewalk and Ramp Standards	66
317	Sidewalk and Ramp Standards, Notes	67

SECTION 100

GENERAL SPECIFICATIONS

101 GENERAL

The following specifications have to do with the general requirements and management of the proposed construction work. They are to provide for the construction of the pavement in its entirety together with all work connected thereto, complete and ready for use by the City of Jackson, Missouri.

102 DEFINITION OF TERMS

102.1 City

Wherever the word "City" is used in these specifications, it shall refer to and designate the City of Jackson, Missouri, acting through its proper representatives.

102.2 City Council

Wherever the words "City Council" are used in these specifications, they shall refer to and designate the duly elected Mayor and Board of Aldermen of the City of Jackson, Missouri.

102.3 Engineer

Wherever the word "Engineer" is used in these specifications, it shall refer to and designate the City Engineer of the City of Jackson, Missouri, or his authorized agents limited by the particular duties entrusted to them.

102.4 Excavation

Excavation shall include all cuts, fills, and all necessary moving of earth or other material for whatever purpose, where such work is an essential part of or necessary to the prosecution of the contract; and shall also include all clearing and grubbing, dressing, rolling or other work required in the preparation of the subgrade.

102.5 Contractor

Wherever the word "Contractor" is used in these specifications, it shall refer to the individual, company, or corporation to whom the contract for this improvement has been awarded.

102.6 Plans

Annexed hereto and made a part of the contract and the specifications is a set of plans, setting out in detail the nature of the work to be done, and consisting of the following: See plans for each separate improvement.

102.7 Parkway

All land within City right-of-way except where covered by roadway surfacing.

102.8 Subgrade

The graded soil base upon which a base or road surface is to be placed.

102.9 Base

Base, or Aggregate Base, shall be the compacted layer, typically limestone aggregate, placed over the soil subgrade upon which a pavement is to be placed. May also refer to Bituminous (or Asphaltic) Base, placed over an Aggregate Base, prior to placement of an Asphaltic Concrete Pavement.

102.10 Night Work

Night work shall be any work done between sunset and sunrise.

103 SPECIFICATIONS

Unless specifically mentioned, the word "Specifications" as hereinafter used, shall refer to these specifications. The Plans and Specifications are intended to be complete, but should anything be omitted in the specifications and shown on the plans, or omitted in the plans and set out in the specifications, such omission shall be supplied by the contractor as if both fully specified and drawn.

The Bidder is expected to examine carefully the site of the proposed work, the proposal, plans, specifications, supplemental specifications, special provisions, standard conditions, supplementary standard conditions, and contract forms before submitting a proposal. The conditions indicated on the plans and in the proposal represent information available from surveys and studies, but the submission of a bid shall be considered proof that the Bidder has made his own examination and is satisfied as to the conditions to be encountered in performing the work and as to the requirements of the plans, specifications, supplemental specifications, special provisions, and contract.

104 INTERPRETATION OF PLANS AND SPECIFICATIONS

The plans and specifications are intended to be explanatory of each other, but should any discrepancies appear between the drawing and the specifications, or between any of the several

drawings themselves, such discrepancies shall be interpreted, explained, and adjusted by the Engineer, and any doubts or misunderstandings as to the meaning or intent of the specifications, or any obscurity in the wording of the same, shall be explained by the Engineer, who shall have the right to correct any errors or omissions in them, when such correction is found necessary for the proper fulfillment of their intentions; the correction to be effective at the time the Engineer shall give notice thereof.

The Engineer may, at his own discretion, furnish additional detail plans to which the contractor will be required to conform. However, these detail plans shall, if given, be only an elaboration or fuller interpretation of the plan already on file and upon which the preliminary estimate has been based.

105 INSTRUCTIONS

All instructions to the contractor relating to the work shall be given through the Engineer and the contractor shall obey all instructions so given concerning the method of procedure throughout the work.

106 INSPECTION

The Contractor shall provide 48 hours notice to the Department of Public Works at (573) 243-2300 prior to the start of work. When work is interrupted, or stopped for more than 24 hours, the Contractor shall request an inspection 24 hours in advance of the need for an inspection.

All materials furnished, and all work done, will be inspected by the Engineer, and if found not to be in accordance with the specifications and the contract, will be rejected and shall be removed from the site of the work. Other material shall then be furnished and other work done that is in accordance with the provisions and requirements set out in the specifications.

If the contractor shall fail or refuse to remove the material as above, or do other acceptable work when ordered, the Engineer shall have the right and authority to stop the contractor and his men at once.

The contractor shall furnish all necessary facilities should it be advisable to make an examination of the work already completed. The Engineer shall have the right to reject at any time any work or material that may be found faulty; but no inspection or orders given during the progress of the work shall in any way invalidate the Contractor's bond, nor in any way hinder the City from recovering under same.

107 NIGHT AND SUNDAY WORK

No night work requiring the presence of an Engineer or Inspector will be permitted, except in case of emergency, and then only to an extent as is absolutely necessary, and with written permission of the Engineer.

No Saturday or Sunday work will be permitted, except in case of great emergency, and then only with written consent of the Engineer.

108 EXECUTION OF THE WORK

The contractor shall begin work not later than the date set out in the contract, and shall proceed with the same diligently and uninterruptedly, so as to complete same within the time set out in the contract, and shall be responsible for the entire work embraced in his contract until completed and accepted by the City and until he is formally released.

Until work is accepted by the Engineer, it shall be in the custody and under the charge and care of the contractor. The contractor shall rebuild, repair, restore, or make good at his expense, any lost or stolen City owned materials and all injuries or damages to any portion of the work before its completion and acceptance caused by the action of the elements or from any other reason. Issuance of a payment estimate on any part of the work done will not be considered as final acceptance of any work completed up to that time.

The contractor shall erect and maintain proper barriers at all times in accordance with the most recent edition of the Manual on Uniform Traffic Control Devices, including warning and detour signs as directed, flares or red lights at night, to guard against any accident in consequence of the work. When so directed by the Engineer, the contractor shall install permanent barricades which shall positively prevent the entrance of any vehicle on the grade or finished pavement, until permission is granted by the Engineer to remove same. Such barricades shall be constructed of materials and of a fashion as directed by the Engineer. The whole cost of such work shall be considered as fully covered by the price bid for the other items in the contract.

The contractor shall be held responsible for all damage to life and property occasioned in any way by his acts and those of his agents or employees. The contractor shall carry liability insurance and Workman's Compensation Insurance and public liability insurance, together covering bodily injuries to his employees and the public, received as a consequence of the performance of the work under contract.

109 LINES AND GRADES

All necessary lines and grades will be given by the Engineer. If the contractor through willfulness or through carelessness causes or allows the said marks to be removed before the work required of them, the replacing of the same shall be done at the expense of the contractor and not chargeable to the engineering service.

110 FOREMAN

At all times when the work is in progress, the contractor shall maintain a competent foreman or head-workman on the ground, also a copy of the plans and specifications. Instructions given said foreman or head-workman shall be considered as having been given to the contractor. Contact phone numbers for the foreman shall be supplied to the City at the

preconstruction conference or before the work begins.

111 MATERIALS, LABOR, TOOLS, ETC.

The contractor shall furnish, at his own cost and expense, all transportation, plant, tools, labor, materials, and all else requisite to execute and complete the work in the best possible and most expeditious manner according to the plans and specifications.

He shall employ only competent personnel, and shall discharge immediately, whenever required to do so by the Engineer, any man considered by the Engineer as incompetent or disorderly, or who shall refuse to obey the instructions as given to the contractor or his foreman, and shall not again employ such person on the work.

Local labor will be given preference for all classes of work, excepting those which, by their nature, demand the service of skilled mechanics for their economical and satisfactory completion.

112 CONDUITS IN STREET, MANHOLES, ETC.

The contractor must allow proper opportunity for relaying pipe or conduit of all kinds, and he will be held responsible for all damage done to them during the extension of the work.

Sewer manholes, water valves, and pipe ends encountered in the improvement shall be adjusted to the finished grade of the pavement, or parkway, by the contractor, whether same are raised or lowered. The cost of the above work, except as otherwise provided on the plans, shall be covered by the unit price bid for the pavement, and shall include the cost of all labor, material, and equipment, and all else necessary.

113 PROTECTION TO FINISHED WORK

The contractor will be held responsible for any and all materials or work and will be required to make good at his own cost any injury or damage which said material or work may sustain from any source or cause whatever before the final acceptance of the same.

114 PROVISIONS FOR DRAINAGE AND TRAFFIC

If it is necessary in the prosecution of the work to interrupt or obstruct the natural drainage of the surface, or the flow of the artificial drainage, the contractor shall provide for the same during the progress of the work, in such manner that no damage will result to either public or private interests.

The contractor shall conduct his work so as to interfere as little as is possible with traffic and so as to inconvenience as little as possible the citizens residing along the lines of the work. The contractor shall notify adjacent property owners by an approved door-hanger notice at least 48 hours prior to restricting access to private property adjoining the work.

115 CLEANING UP - DRIVEWAYS

The contractor shall remove all materials and debris from the streets as the work progresses so that the public may have the use of the street as soon as is possible.

Before the work will be considered complete, all rubbish and unused material due to or connected with the construction must be removed to the satisfaction of the Engineer. Sidewalks and adjoining property that have been damaged or disturbed by the work shall be restored to their original condition.

The contractor shall excavate any driveway existing at the time the improvement is started, which have been made inaccessible by the construction, so that suitable access may be had to the property after the improvement has been completed, and before it is accepted. The cost of such work shall be completely covered by the price bid for excavation. It shall not be required that such driveways be surfaced by the contractor, unless otherwise shown.

116 EXTRA WORK AND CHANGE ORDERS

All work required to be done that is not necessarily a part of the contract, or is necessary for carrying out the full intent of the plans and specifications, and for which no price has been bid, may be required of the contractor by a Change Order modifying said contract. Payment for extra work will be based on lump sum or unit prices previously agreed to in the contract, or a price agreed to and included in a Change Order. The contractor shall give the Engineer access to all accounts, bills, and vouchers relating to the cost of the extra work. Additional time for completion of extra work will only be allowed as specified in an approved Change Order.

117 ENGINEER'S MEASUREMENTS

It is understood and agreed by the parties hereto that the estimate of the Engineer shall be final and conclusive evidence of the amount of work performed by the contractor under and by virtue of his contract, and that the said estimate shall be taken as a measure of compensation to be received by the contractor, unless material delivery tickets and final quantity measurements show otherwise.

The aforesaid estimate will be based on the actual quantities as determined by actual measurement together with the unit prices stipulated in the Proposal. To this estimate will be added, however; such amount as is due the Contractor on account of extra work that has been done or as ordered by Change Order, and as specified under "Extra Work" together with the actual cost of engineering services.

SECTION 200

DETAILED SPECIFICATIONS

201 GENERAL

The following specifications have to do with the general requirements of the material and labor necessary for the proper execution of the proposed construction work.

They are intended to provide for the entire completion of the work embraced in the contract in a thorough, complete, and workmanlike manner; but should these specifications not specifically mention certain requirements of the plans, the material and workmanship for such omissions shall be the best of their kind and character.

202 EXCAVATION CLASSIFICATION

All excavation shall consist of two classifications, namely, Class “A” and Class “B”.

Class “A” Excavation shall include solid rock in original beds or well defined ledges, and all boulders or detached pieces of stone twenty-seven (27) cubic feet or more in content, that cannot be removed by rock excavating equipment equivalent to the following in size and performance ratings, without systematic drilling, ram hammering, ripping, or blasting when permitted:

1. Excavation of Footings, Trenches, and Pits: Late-model, track-mounted hydraulic excavator; equipped with a 42-inch-wide, short-tip-radius rock bucket; rated at not less than 120-hp flywheel power with bucket-curling force of not less than 25,000 lbf and stick-crowd force of not less than 18,700 lbf; measured according to SAE J-1179.
2. Bulk Excavation: Late-model, track-mounted loader; rated at not less than 210-hp flywheel power and developing a minimum of 45,000-lbf breakout force; measured according to SAE J-732.

All such rock shall be removed to a minimum of six (6) inches below subgrade-surface.

Class “B” Excavation shall consist of all excavated materials not mentioned under Class “A” Excavation.

202.1 Cuts and Fills

Earth in excavation may be removed to an elevation slightly above that of the finished subgrade as indicated on the plans, then brought to the true grade with a self-propelled roller weighing not less than five (5) nor more than ten (10) tons, or other approved roller. Sheepsfoot rollers shall be utilized when appropriate. Where this method does not provide minimum compaction as set out in Section 203.1(a) (Subgrade) the subgrade shall be scarified and recompacted to those requirements.

All embankments made of material from the cuts in the street itself are to be made without additional compensation, the price for the excavation to cover the cost of placing the material in the embankments. Excess materials shall be deposited as may be directed by the Engineer. Material in excess of that needed to make all fills on the work under contract shall be deposited as directed by the Engineer in such quantity as is directed, and any remaining excavated material shall be the property of the contractor and shall be disposed of by him in a satisfactory manner.

If so directed by the Engineer, the contractor shall scarify and windrow existing gravel or similar surfacing for removal to be utilized by City forces elsewhere.

The contractor shall preserve without damage the vegetation designated by the Engineer to remain. All trees, stumps, brush, and hedge not designated to remain shall be cleared and grubbed as required and shall be disposed of in an acceptable manner.

Stumps and roots in cut areas shall be removed to a depth of not less than twelve (12) inches below the finished earth grade. Removal of Osage Orange or Locust hedge shall include removal of roots. In embankment areas, undisturbed stumps and roots extending not more than six (6) inches above the ground line may remain, provided they are a minimum of three (3) feet below the finished earth grade or slope of the embankment. Except in areas to be excavated, stump holes shall be backfilled with suitable material and compacted to the approximate density of the adjacent area. In lieu of removing, stumps outside of the slope stake limits may be cut off not more than three (3) inches above the ground. Clearing of borrow areas, channel changes, and inlet and outlet easements will be required only to the extent necessitated by the proposed construction.

When embankment is to be placed on hillsides or when new embankment is to be constructed against existing embankments, the existing slopes that are steeper than six (6) to one (1) when measured at right angle to the roadway shall be continuously benched in not less than twelve (12) inch rises over those areas where it is required as the work is brought up in layers. Benching shall be sufficient width to permit placing and compacting operation. Each horizontal cut shall begin at the intersection of the ground line and the vertical side of the previous bench. Existing slopes shall also be stepped to prevent any wedging action of the embankment against structures. No direct payment will be made for the material thus cut out nor for its compaction along with the new embankment material.

Fills shall be formed of earth or other approved materials and shall be constructed in successive layers. Each layer which shall not exceed one (1) foot in depth shall be thoroughly rolled with a sheepsfoot roller or other equipment approved by the Engineer, and compacted to ninety percent (90%) of maximum density as determined by the American Association of State Highway Officials (AASHTO) T-99 Standard Compaction Test.

Cut and fill areas within the limits of proposed streets shall be tested per Section 202.4(a).

Slopes in both excavation and embankment shall be neatly dressed to the lines shown on the cross sections, unless other lines are approved by the Engineer.

No frost or frozen material shall be incorporated in subgrade or embankments.

202.2 Borrow

When "Borrow" is specifically designated in the bid documents, and when the material excavated from the cuts is not sufficient to make the fills shown on the plans, the contractor shall supply the necessary material and will be paid therefore at the unit price bid for "Borrow", per cubic yard computed by the average end area method as measured in place at the borrow pit.

202.3 Payment for Excavation

Payment for excavation will be made at the unit price bid for Excavation or Borrow, or both, as the case may be and shall be full compensation for all work set out under Excavation.

The volume of excavation shall be computed by the average end area method measured in place.

Where payment for excavation has been included in the price bid for pavement in the Engineer's estimate for the proposal, such price shall include full compensation for Excavation and Borrow and all other items set out under Excavation.

203 SUBGRADE AND BASE

203.1 Subgrade

That portion of the graded soil roadbed upon which surfacing is to be placed is hereby designated as the subgrade. The subgrade shall be constructed so that it will be uniform in density throughout its entire width and will conform to the line, grade, and cross section shown on the plans or as established by the Engineer.

203.1(a) Subgrade Construction

The subgrade shall be brought to a firm, unyielding surface by rolling the entire area with a sheepsfoot or a self-propelled roller weighing not less than five (5) nor more than ten (10) tons and all portions of the surface of the subgrade which are inaccessible to the roller shall be thoroughly tamped with an approved mechanical tamper or a hand tamp weighing not less than fifty (50) pounds, the surface of which shall not exceed one hundred (100) square inches in area. All soft, spongy, or yielding spots, and all vegetable or other perishable matter shall be entirely removed and the space refilled with suitable material. The cost of removal and refilling should be included in the unit price bid. It is not an Extra Work item. It shall then be tested with an approved template furnished by the Contractor. If the subgrade is not to the proper elevation, material shall be added or removed as required and it shall be compacted in a manner satisfactory to the Engineer. This process shall be repeated until all irregularities are removed. Extreme care shall be taken in shaping the subgrade, so that at no place will the completed surface vary more than 1-inch from the specified grade.

Subgrade shall be compacted to ninety percent (90%) of AASHO T-99 Standard Compaction Test for all pavements. When considered necessary in producing better compaction, the subgrade shall be sprinkled with water before rolling. After compaction, a loaded tandem axle dump truck (proof-roller) shall be driven over the entire length of the project in at least two (2) passes per paved lane to locate soft areas or other issues.

Subgrade shall extend a minimum of two (2) feet beyond the back of curb or extent of pavement.

203.1(b) Disturbed Subgrade

If the subgrade is excavated, trenched, or otherwise disturbed for the placement of utilities such as stormwater conveyances, water or wastewater pipe, compacted granular backfill material shall be required. Granular materials meeting the requirements of Type 1 or Type 5 aggregate as specified in sections Sec. 202.4(a) shall be used full depth under roadways and in shoulder areas in which the distance from the edge of the roadway surface is equal to the depth of the excavation, except twelve (12) inches of topsoil on the surface for turf establishment behind curbs. All backfill materials shall be compacted in eight to twelve (8 to 12) inch lifts, dependent on capabilities of compaction equipment, to ninety-five percent (95%) of Maximum Standard Procter. Density tests shall be recorded by the contractor on the first trench on any one job for at least the first and last lifts compacted in the trench. Additional density tests may be

required by the Engineer. No utilities shall be located within two (2) feet of the back of curb, except in special instances where approved by the Director. This backfill must be compacted to at least ninety-five percent (95%) of Maximum Standard Procter Density for the backfill material used. Compacted earth is not considered an acceptable trench backfill material under pavement limits or within two (2) feet thereof.

Any attempt to compact subgrade or base under forms set for pavement, curb, or curb and gutter, where subgrade or base is low, will not be permitted. The forms shall be removed and the subgrade or base corrected and compacted, and then the forms replaced to proper grade and alignment. If the subgrade or base is affected by weather, all reinforcing steel and forms shall be removed to allow the entire subgrade to be compacted as a single unit.

When a new pavement is to be constructed over an old roadbed composed of gravel or macadam, the old roadbed shall be entirely scarified into the subgrade as directed by the Engineer and the material spread for the full width of the roadbed and rolled until pumping or rutting does not occur. All interstices shall be filled with fine material and rolled to make a dense, tight surface of at least ninety percent (90%) of Maximum Standard Procter Density. Where necessary, material shall be graded to the side to allow all subgrade and base material to be compacted in eight (8) inch maximum lifts.

203.1(c) Subgrade Inspection

No aggregate base shall be deposited until the subgrade is checked and accepted by the Engineer. The contractor shall furnish and use as part of his equipment a "scratch template", approved by the Engineer for the purpose of preparing and checking the depth of the subgrade and granular base between the forms set for the pavement. The contractor shall have inspected and checked grades prior to calling for a City inspector's approval. Where hauling creates ruts, the contractor shall reshape and reroll the subgrade before aggregate base or concrete is deposited. The subgrade cannot be used as a haul road. Trucks are only allowed to drive on the subgrade for dumping.

203.2 Density Tests

Subgrade shall be compacted to ninety percent (90%) of AASHO T-99 Standard Compaction Test. Density tests shall be recorded by the contractor and provided to the City for all earthwork operations. The subgrade of all street pavements shall be re-tested for compaction if the road is to be used as a haul road for concrete trucks and other heavy equipment. One (1) density test shall be taken and recorded as a minimum every one thousand (1,000) cubic yards of earth backfill placed, and/or every five hundred (500) square yards of pavement subgrade cut to grade as indicated on the project plans or as measured in the field. Density tests shall be required in each fill area where the area is not continuous. Density tests shall be repeated by Contractor if subgrade is degraded due to weathering or disturbed by equipment. No aggregate base material shall be placed on subgrade for pavement prior to approval by the Engineer.

203.3 Aggregate Base Material

Type 1 Aggregate.

Aggregate for Type 1 base shall be essentially limestone. The crushed stone shall not contain deleterious material such as shale or disintegrated stone in excess of fifteen percent (15%). Any silt, any clay, and any deleterious material shall be uniformly distributed throughout the mass. The aggregates shall conform to the following gradation requirement:

Passing 1 inch sieve 100%
Passing 1/2 inch sieve 60-90%
Passing No. 4 sieve 35-60%
Passing No. 30 sieve 10-35%

Type 5 Aggregate.

Aggregate for Type 5 base shall consist of crushed limestone, limestone screening, sand and gravel. The aggregate shall not contain more than fifteen percent (15%) deleterious rock and shale. If crushed stone is used, sand may be added only for the purpose of reducing the plasticity index of the fraction passing the No. 40 sieve in the finished product. The fraction passing the No. 40 sieve shall have a plasticity index not to exceed six (6). Any sand, silt and clay, and any deleterious rock and shale shall be uniformly distributed throughout the material. When sand and gravel aggregate are used, the fraction passing the No. 200 sieve shall be less than one half of that fraction passing the No. 30 sieve. The material shall conform to the following gradation requirements and in addition shall be so graded that it will readily compact to the specified density and withstand construction traffic without distortion and displacement:

Passing 1 inch sieve 100%
Passing 1/2 inch sieve 60-90%
Passing No. 4 sieve 35-60%
Passing No. 30 sieve 10-35%
Passing No. 200 sieve, 0-15%

If flint chat or tuff chat is used, it shall meet the requirements of this section and in addition shall have at least twenty percent (20%) passing the No. 40 sieve.

Payment is per Contract unit price.

203.4 Aggregate Base Construction

There shall be at all times at least fifty (50) feet of approved subgrade and base in the condition described herein ahead of the point at which pavement is being placed.

Concrete pavement aggregate base minimum thickness shall be per the project plans, but in no case shall there be less than four (4) inches of compacted aggregate for six (6) or seven (7)

inch thick concrete pavement and six (6) inches of aggregate for eight (8) inch thick concrete pavement.

Asphalt pavement compacted aggregate base minimum thickness shall be per the project plans, but in no case shall be less than six (6) inches for local residential streets and eight (8) inches for collector streets.

The compacted aggregate base material shall not vary more than one (1) inch from the required grade.

Aggregate base material shall extend one (1) foot beyond the back of curb or edge of pavement. The aggregate material shall be compacted to no less than ninety-five percent (95%) Standard Procter Maximum Density. Moisture shall be added to the material during compaction only when it is necessary to obtain the required density. Measurement for payment of the aggregate shall be by truck ticket or computed to the lines and grades of the aggregate on plans and weighing one hundred sixteen (116) pounds per inch per square yard plus five percent (5%) for moisture, whichever is smaller. All extra aggregate used under pavements shall be the contractor's responsibility. Once aggregate is in place, the inspector will perform the necessary tests to ensure the minimum depth. If aggregate is less than the required depth, then aggregate shall be removed and subgrade shall be lowered to obtain the required depth. No pavement shall be placed until aggregate base is approved by the Engineer.

204 ASPHALTIC CONCRETE PAVEMENT

Asphaltic Concrete Pavement and Asphaltic Base Course shall be of the type, thickness, and width as shown on the plans and of a quality conforming to the requirements of Section 401, Plant Mix Bituminous Base and Pavement, as found in the Missouri State Highway Commission Standard Specifications Edition of 2004, which specifications are hereby incorporated by this reference except as modified herein.

A Missouri Department of Transportation (MoDOT) approved mix design and Quality Control (QC) plan shall be submitted for each project and approved by the engineer prior to the beginning of work.

204.1 PLANT MIX BITUMINOUS BASE

204.1(a) Subgrade and Aggregate Base

The bituminous mixture shall be placed upon a subgrade and aggregate base prepared as specified in Section 203.

204.1(b) Transportation

The prepared mixture shall be transported from the paving plant to the work in tight vehicles previously cleaned of all foreign materials. The inside of truck beds shall be lubricated with a thin oil to prevent the mixture from adhering to the bed but an excess of lubricant will not be permitted. Each load shall be covered with canvas or other suitable material of sufficient size to protect it from the weather. No loads shall be sent out so late in the day that spreading and compacting of the mixture cannot be done during daylight.

204.1(c) Spreading

The base course, primed surface, or preceding course shall be cleaned of all dirt, packed soil or any other foreign material prior to spreading the bituminous mixture. When delivered to the roadbed, the mixture shall be at a temperature which will permit proper placement and compaction. It shall be spread in the number of courses and to the amount required to obtain the compacted thickness and cross section shown on the plans. The compacted thickness of a single course shall not exceed four (4) inches.

The mixture shall be spread only when the prepared surface or preceding course is dry. Bituminous mixture shall not be mixed or placed when the ambient temperature is below forty degrees Fahrenheit (40°F.), or when there is frost in the subgrade or any other time when weather conditions are unsuitable for the type of material being placed. The mixture shall be spread and finished with an approved spreading and finishing machine. On small areas and on areas which are inaccessible to mechanical spreading and finishing equipment, the mixture may be spread and finished by hand methods when permitted by the Engineer. The surface of each course shall be substantially free from waves and irregularities and the surface of the final course of the bituminous stabilized base shall not vary by more than one-fourth (1/4) inch from a ten

(10) foot straightedge applied parallel to the centerline of the surfacing.

The mixture shall be spread without tearing the surface and struck off so that the surface is smooth and true to cross section, free from all irregularities, and of uniform density throughout. Care shall be used in handling the mixture to avoid segregation. Areas of segregated mixture shall be removed and replaced with suitable mixture. The outside edges of the pavement shall be constructed to an angle of approximately forty-five degrees (45°) with the surface of the roadbed. The outside edge alignment shall be uniform and any irregularities shall be corrected by adding or removing mixture before the edges are rolled.

204.1(d) Leveling Course

If required by the contract, a leveling course consisting of a layer of variable thickness shall be spread to the desired grade and cross section to eliminate irregularities in the existing surface. Spot-leveling operations over small areas, with feather edging at high points and ends of spot areas, may be required prior to placing the leveling course. Rigid control of the placement thickness of the leveling course will be required. The use of an approved finishing machine will be required on the spot leveling and the leveling course, except that the spreading of the spot-leveling with a blade grader will be permitted if results indicate the mixture is practically free from segregation.

204.1(e) Joints

Longitudinal and transverse joints shall be carefully made and well bonded. Transverse joints shall be formed by cutting back on the previous run so as to expose the full depth of the course. Longitudinal joints shall be spaced in such a manner that joints in succeeding courses will be at least six (6) inches horizontally from joints in any preceding course.

204.1(f) Compaction

After spreading, the mixture shall be thoroughly compacted by rolling consisting of initial or breakdown rolling, intermediate rolling, and final or finish rolling. Initial rolling shall be performed with three (3) wheel rollers or two (2) wheel tandem rollers weighing from eight (8) to twelve (12) tons. Intermediate rolling shall be done with an oscillating type pneumatic-tire roller developing at least eighty (80) pounds per square inch contact pressure, or a tandem wheel roller. The Contractor shall furnish evidence regarding tire size, pressure, and loading to confirm that eighty (80) pounds per square inch contact pressure is being developed, and that the loading and contact pressure are uniform for all wheels of pneumatic-tire rollers. Final rolling shall be done with either two (2) or three (3) wheel tandem rollers weighing not less than ten (10) tons. Rollers shall be operated at a speed of not more than three (3) miles per hour and in a manner that will avoid shoving, cracking or displacing the mixture during the compacting period. The mixture shall be rolled when it is at the proper temperature to receive the roller and when rolling does not cause undue displacement or shoving. Initial compaction shall be done when the mixture has cooled just sufficiently to receive the roller. Intermediate and final compaction shall be done while the mixture is warm and malleable enough to respond to the kneading action of the roller. Rolling shall begin at the sides and progress gradually to the center of each lane,

except that on super-elevated curves rolling shall progress from the lower to the upper edge. Rollers shall travel parallel to the center line of the road and uniformly lap each preceding track, until the entire surface has been rolled. Rolling shall be continued until no further compaction is being obtained. All compacted mixtures shall have a density of not less than ninety-two percent (92%) of that obtained by the laboratory compaction of an identical mixture. Any mixture which has become wet from any cause shall not be rolled until the moisture has been permitted to escape.

A sufficient number of rollers shall be supplied to thoroughly compact the mixture. All rollers used shall be in good condition, capable of reversing without backlash and steel wheel rollers shall be equipped with scrapers, a system for moistening each wheel, and shall develop at least two hundred fifty (250) pounds pressure per inch width of tread of the compression roll. Along curbs, headers, and at other places not accessible to the rollers the mixture shall be thoroughly compacted with hand or mechanical tampers.

The surface of the mixture after compaction shall be smooth and true to the established crown and grade. Any mixture showing an excess of bituminous material or one that becomes loose and broken, mixed with dirt, or is in any way defective shall be removed and replaced with satisfactory mixture, which shall be immediately compacted to conform to the surrounding area.

204.1(g) Surface Tolerance.

The finished layers of plant mix bituminous base shall be substantially free from waves or irregularities and shall be true to the established crown and grade. For all pavement, including at transverse construction joints, the surface of all layers shall not vary from a ten (10) foot straightedge, applied parallel to the centerline, by more than one-fourth (1/4) inch. Areas exceeding this tolerance shall be rerolled, replaced, or otherwise corrected in a manner satisfactory to the Engineer.

204.1(h) Tolerance in Pavement Thickness.

It is the intent of these specifications that the plant mix bituminous base course shall be constructed strictly in accordance with the thickness shown on the plans. The total thickness of the pavement will be measured by coring as indicated in Section 204.2. Where any pavement is found deficient in thickness, corrective actions shall be taken as indicated in Section 204.2.

No additional compensation will be allowed the contractor for any plant mix bituminous base course constructed in excess of the thickness requirements of the plans and specifications. The surface from which the cores have been taken shall be restored by the contractor within forty eight (48) hours using a mixture acceptable to the Engineer.

204.1(i) Method of Measurement.

Full depth pavement areas of plant mix bituminous base course will be measured to the nearest one tenth (1/10) square yard. Areas requiring a variable thickness bituminous base course will be measured on a per ton basis. The weight of the bituminous base course for the areas requiring a variable thickness will be determined from weight tickets for each truck delivering base course to the job site. Final measurement for variable thickness base course will be to the nearest one tenth (1/10) ton of acceptable base course.

204.1(j) Basis of Payment.

Payment for all plant mix bituminous base course shall include all labor, materials, and equipment necessary for the construction of the bituminous base course in place. Prime coat will be considered incidental to said construction unless specified separately in the specifications.

Payment for full depth pavement areas of plant mix bituminous base course will be on a square yard basis. Payment for variable thickness bituminous base course will be on a per ton basis. In case a truck load of bituminous base course is to be spread in both areas of full depth pavement and variable depth pavement, the contractor and Engineer shall agree on the tonnage of that portion of the load used in the variable depth area, prior to its placement. The conversation from tons to square yards is based on 110 lbs./sq.yd/inch.

204.2 ASPHALTIC CONCRETE SURFACING

The Asphaltic Concrete Surfacing shall be of a type, thickness, and width as set out in the Standard Drawings, or in the project plans and be of a quality conforming to the requirements of Section 403, Asphaltic Concrete Pavement, and Section 407, Tack Coat, all as found in the Missouri State Highway Commission Standard Specifications Edition of 2004, which specifications are hereby incorporated by this reference except as modified herein.

Profilographing will be replaced by checking for a tolerance of one fourth (1/4) inch in ten (10) feet with a ten (10) foot straightedge on residential and collector streets with speed limits less than forty-five (45) miles per hour. Arterial streets will be profilographed unless otherwise stated in the project plans and specifications.

204.2(a) Weather Limitations.

Bituminous mixtures shall not be placed when:

- (1) either the air temperature or the temperature of the surface on which the mixture is to be placed is below 40 degrees F and falling,
- (2) on any wet or frozen surface, or
- (3) when weather conditions prevent the proper handling or finishing of the mixture.

204.2(b) Subgrade Preparation.

The subgrade upon which bituminous surface course is to be placed shall be prepared in

accordance with the bituminous surface course is to be placed upon the top of a completed base course or existing hard surfaced pavement, then the base course or existing pavement will be considered the subgrade for the next operation.

204.2(c) Tack Coat.

- (1) Material. The asphalt cement material used for tack coat shall be emulsified asphalt meeting the requirements of AASHTO M140 or M208, and shall be Grade SS-1 or SS-1H as designated by the Engineer.
- (2) Preparation of Surface. The existing surface shall be free of all dust, loose material, grease, or other foreign material at the time the tack is applied. Any fat bituminous surface mixture or bituminous joint material shall be removed before the tack is applied. The surface shall be dry when the tack is applied, except in the case of emulsified asphalt.
- (3) Application. Bituminous material shall be applied uniformly with a pressure distributor at the following rates:

<u>Type of Surface</u>	<u>Rate-gallons per square yard</u>	
	<u>Minimum</u>	<u>Maximum</u>
Absorbent	0.2	0.5
Non-absorbent	0.02	0.1

In using emulsified asphalt, water may be added to the material and mixed therewith in such proportion that the resulting mixture will contain not more than fifty (50) percent of added water, the exact quantity of added water to be approved by the Engineer. The application of the resulting mixture shall be such that the original emulsion will be spread at the specified rate. The tack material shall be heated at the time of application to a temperature specified in the table below. The tack material shall be properly cured and the tacked surface shall be cleaned of all dirt and surplus sand before the next course is placed.

Application Temperatures				
Bituminous Material	Temperature, Degrees Fahrenheit			
	Spraying		Mixing	
	Min.	Max.	Min.	Max.
Asphalt Emulsions SS1	75	130	75	130
SS1H	75	130	75	130

The tack coat shall be applied in such a manner as to cause the least inconvenience to traffic. The tack may be applied full width, provided

the tacked surface is blotted with sand in such quantity as specified by the Engineer before it is opened to traffic.

204.2(d) Transportation

Trucks used for hauling bituminous mixtures shall have tight, clean, smooth, metal beds which have been thinly coated with a minimum quantity of paraffin oil, lime solution, or other approved material to prevent the mixture from adhering to the bed. Each load shall be covered with canvas or other suitable material of sufficient size to protect the mixture from the weather. When necessary, truck beds shall be insulated so that the mixture will be delivered on the road to meet the requirements of Paragraph 4e. No loads shall be sent out so late in the day that spreading and compacting of the mixture cannot be completed during daylight.

204.2(e) Spreading

The base course, primed surface, or preceding course or layer shall be cleaned of all dirt, packed soil, or any other foreign material prior to spreading the bituminous mixture. When delivered to the roadbed, the mixture shall be at a temperature which will permit proper placement and compaction. It shall be spread with an approved spreading and finishing machine in the number of layers and in the quantity required to obtain the compacted thickness and cross section shown on the plans. The paver shall be operated at a speed that will give the best results. The rate of delivery of the mixture to the paver shall be coordinated so as to provide, where practicable, a uniform rate of placement without intermittent operation of the paver. The compacted thickness of a single layer shall not exceed two (2) inches for the surface course and four (4) inches for the leveling course. On small areas, and on areas which are inaccessible to mechanical spreading and finishing equipment, the mixture may be spread and finished by hand methods when permitted by the Engineer.

- (1) Surface Condition. The mixture shall be spread without tearing the surface and struck off so that the surface is smooth and true to cross section, free from all irregularities, and of uniform density throughout. Care shall be used in handling the mixture to avoid segregation. Areas of segregated mixture shall be removed and replaced with suitable mixture. The outside edges of the pavement shall be constructed to an angle of approximately forty-five (45) degrees with the surface of the roadbed. The outside edge alignment shall be uniform and any irregularities shall be corrected by adding or removing mixture before compacting.
- (2) Spot Wedging and Leveling Course. Leveling course, consisting of a layer of variable thickness used to eliminate irregularities in the existing surface, shall be spread to the desired grade and cross section. Rigid control of the placement thickness of the leveling course will be required. Spot wedging operations over small areas, with featheredging at high points and ends of spot areas, may be required prior to placing the leveling course. The use of an approved finishing machine will be required on the spot wedging and the leveling course, except that

the spreading of the spot wedging with a blade grader will be permitted if results indicate the mixture is practically free from segregation.

204.2(f) Joints

Longitudinal and transverse joints shall be made in a careful manner. Well bonded and sealed joints are required. Joints between old and new pavements, or between successive day's work shall be carefully made in such a manner as to insure thorough and continuous bond between the old and new surfaces. Hot soothers or tampers shall be carefully employed in such a manner as to heat up the old pavement sufficiently (without burning it) to insure a proper bond. Before placing mixture against them, all contact surfaces of dry longitudinal joints, curbs, gutters, headers, manholes, etc., shall be painted with a thin uniform coating of primer. In making the joint along any adjoining edge such as a curb, gutter, or an adjacent paving and after the hot mixture is placed by the finishing machine, just enough of the hot material shall be carried back to fill any space left open. The joint shall be properly "set-up" with the back of rake at proper height and level to receive the maximum compression under rolling. The work of "setting-up" this joint shall be performed always by competent workmen who are capable of making a correct, clean, and neat joint. If approved by the engineer, tar paper may be placed over a transverse joint at the end of a day's work prior to placing additional material to form a smooth and drivable transition.

204.2(g) Surfaced Approaches

At locations designated in the contract or as specified by the Engineer, approaches shall be tacked in accordance with Section 204.2(c) and surfaced with a plant mix bituminous mixture. The bituminous surface shall be placed in accordance with the details shown on the typical section or as specified by the Engineer. Approaches shall not be surfaced until after the surface course adjacent to the entrance is completed. No direct payment will be made for any work required to condition and prepare the subgrade on the approaches.

204.2(h) Compaction

Compaction of asphaltic mixtures shall consist of initial or break-down rolling, intermediate rolling, and final or finish rolling. Except for projects involving small quantities of mixture, initial rolling shall be performed with three (3) wheel rollers or two (2) wheel tandem rollers weighing from eight (8) to twelve (12) tons. Intermediate rolling shall be done with oscillating type pneumatic-tire rollers if required by the Engineer; otherwise it shall be done with either two (2) or three (3) wheel tandem rollers. Final rolling shall be done with either two (2) or three (3) wheel tandem rollers weighing not less than ten (10) tons. Rollers shall be operated at a speed of not more than three (3) miles per hour and in a manner that will avoid shoving, cracking or displacing the mixture during the compacting period. The Contractor shall furnish a sufficient number of rollers to compact and finish satisfactorily the amount of mixture being placed.

The mixture shall be rolled when it is at the proper temperature to receive the roller and

when rolling does not cause undue displacement or shoving. This proper temperature varies with the atmospheric condition and type of mixture. Initial compaction shall be done when the mixture has cooled just sufficiently to receive the roller. Intermediate and final compaction shall be done while the mixture is warm and malleable enough to respond to the kneading action of the roller. Rolling shall begin at the sides and progress gradually to the center of each lane. Rollers shall move parallel to the center line of the roadway and uniformly lap each preceding track. Alternate trips of the roller shall be terminated in steps to prevent the formation of surface irregularities. The alternate stops shall be spaced in such a manner that any excess water will drain quickly. Lateral or diagonal rolling may be permitted to remove high spots, provided the rolling is done in such a manner and at such a time that shoving or cracking will not result. To prevent adhesion of the mixture, steel roller wheels shall be properly moistened, but an excess of water will not be permitted.

All mixtures shall be thoroughly compacted, and rolling shall be continued until no further compaction is being obtained. Except as otherwise specified, all compacted mixtures shall have a density not less than ninety-five percent (95%) of that obtained by the laboratory compaction of an identical mixture.

Along curbs, headers, manholes and similar structures and at all places not accessible to the roller, thorough compaction must be secured by means of hot tampers and at all contacts of this character the joints between these structures must be effectively sealed.

The compacted course shall be free of surface irregularities and shall conform to the grade and dimensions shown on the plans. Weak areas resulting from excess quantities of asphalt, segregation of aggregate or asphalt, areas which become loose or broken, mixed with dirt, or are in any way defective, shall be removed and replaced with fresh hot mixture, compacted to conform with the surrounding area, at the Contractor's expense.

No asphaltic concrete surface may be opened to traffic before it cools to 100°F.

204.2 (i) Surface Tolerances

The finished courses shall have the nominal thickness shown on the plans and shall be substantially free from waves or irregularities and shall not vary from a ten (10) foot straight edge by more than one-half (½) inch on the first and intermediate layers. The final riding surface, except on medians and similar areas, shoulders, and temporary bypasses shall not vary from a ten (10) foot straightedge, applied parallel to the centerline, by more than one fourth (1/4) inch. At transverse construction joints, the surface of all layers shall not vary from the ten (10) foot straightedge by more than one fourth (1/4) inch. Surfaces exceeding these tolerances shall be re-rolled, replaced, or otherwise corrected in a manner satisfactory to the Engineer.

The surface of the mixture after compacting shall be smooth and true to the established crown and grade. Any mixture showing an excess of asphalt cement or that becomes loose and broken, mixed with dirt or is in any way defective shall be removed and replaced at the contractor's expense with a satisfactory mixture, which shall be immediately compacted to conform to the surrounding area.

204.2(j) Tolerance in Pavement Thickness

It is the intent of these specifications that the plant mix bituminous surface course shall be constructed strictly in accordance with the thickness shown on the plans. The total thickness of both the plant mix bituminous surface course and the plant mix bituminous base course will be measured, and where the total thickness is found to be deficient, corrective actions will be taken.

The total combined thickness of the bituminous surface course and the bituminous base course will be measured and determined by average caliper measurement of cores. For the purpose of determining the constructed thickness, ten (10) cores per mile will be taken at random intervals in each traffic lane. In addition, cores may be taken at other locations for a minimum of three (3) per job, or as may be determined by the Engineer. If the measurement of any core is deficient from the plan thickness, additional cores will be taken at twenty-five (25) foot intervals parallel to centerline ahead and back of the affected location until the extent of the deficiency has been determined.

It will be assumed that each core is representative of the total combined thickness for a distance extending one-half the distance to the next core, measured along centerline, or in the case of a beginning or ending core, the distance will extend to the end of the pavement section.

For new full-depth construction of pavement seven (7) inches in thickness or greater, in those areas of deficient thickness in excess of one-fourth (1/4) inch that cannot be corrected without affecting the plan crown and grade, the Director of Public Works has the option of requiring removal of the entire bituminous pavement and replacing it with bituminous base course and bituminous surface course of proper thickness, or leaving the bituminous pavement in place and requiring the following deductions in payment.

Deficiency in Thickness of Full-Depth Street Construction	Deduction Percent of Contract Unit Price
0 inch to 1/4 inch	None
Over 1/4 inch and not over 1/2 inch	50
Over 1/2 inch and not over 3/4 inch	100

For pavement overlays of one and one half (1 1/2) inches or greater, the thickness in those areas of deficient thickness in excess of one-fourth (1/4) inch that cannot be corrected without affecting the plan crown and grade, the Director of Public Works has the option of requiring removal of the entire bituminous pavement overlay and replacing it with bituminous surface course of proper thickness, or leaving the bituminous pavement in place and requiring the following deductions in payment.

Deficiency in Thickness of Partial Overlay Construction	Deduction Percent of Contract Unit Price
0 inch to ¼ inch	None
¼ to 3/8 inch	50
Over 3/8 inch, but not over ½ inch	100

No additional compensation will be allowed the contractor for any plant mix bituminous pavement constructed in excess of the thickness requirements of the plans and specifications. The surface from which the cores have been taken shall be restored by the contractor within 48 hours using a mixture acceptable to the Engineer.

If removal of the pavement is required, the contractor will be required to remove the pavement and to replace it with one of a satisfactory quality and thickness which, when accepted, will be included in the pay quantities. No payment will be made for any costs incurred in the removal of the pavement deficient in thickness or for the original pavement placement.

204.2(k) Deficient Pavement on Private Projects

Prior to acceptance of private projects by the City, cores will be taken to determine pavement thickness as specified in section 204.2(j). In those areas of deficient thickness that cannot be corrected without affecting the plan crown and grade, the Director of Public Works has the option of requiring removal of the entire bituminous pavement and replacing it with bituminous base course and bituminous surface course of proper thickness per section 204 or leaving the bituminous pavement in place and submitting a remittance to the City in an amount equal to the value of deduction shown in section 204.2(j), above using current pricing as determined per City bidding practices. This amount is to offset future maintenance costs necessary because of the deficient pavement. Pavement deficient in thickness in excess of one-half (3/4) inch will not be accepted.

204.2(l) Method of Measurement

Final measurement of plant mix bituminous surface course will be made to the nearest one-tenth (1/10) square yard.

204.2(m) Basis of Payment

Payment for plant mix bituminous surface course shall be paid on a square yard basis and shall include all labor, material, and equipment to construct plant mix bituminous surface course in place. Tack coat will be considered incidental to said construction unless specified separately in the specifications.

204.2(n) Concrete Curb and Gutter

Requirements governing aggregates, proportioning, mixing and handling, curing and protection, as set out for concrete under Section 205 (Portland Cement Concrete Pavement Slab) shall apply to concrete curb and gutter.

205 PORTLAND CEMENT CONCRETE PAVEMENT SLAB

205.1 General

Upon the prepared base shall be laid a course of Portland Cement Concrete of the thickness and width shown in the Standard Drawings, or on the project plans.

205.1(a) Portland Cement Concrete Mix Designs

Materials:

Regular Concrete---Proportion normal-weight concrete mixture as follows:

1. Minimum Compressive Strength: 4000 PSI at 28 days.
2. Minimum Cementitious Materials Content: 597 lb/cy. (6.35 Bag)
3. Slump Limit: 3 inches, plus or minus 1 inch.
4. Air Content: 6 percent, plus or minus 1.5 percent at point of delivery.
5. Maximum Water-Cementitious Materials Ratio: 0.45, or 31.8 gal/cy mixing and aggregate moisture.
6. Coarse Aggregate shall be Gradation B as described in Section 1005.2 of the *Missouri Standard Specifications for Highway Construction 2004*. 1,879lbs/cy
7. Fine Aggregate shall be per Section 1005.3 of the *Missouri Standard Specifications for Highway Construction 2004*. 1128 lbs/cy
8. Any variation or additions to the concrete mix must be approved by the City Engineer.

Aggregate Base per Section 202.

High Early Mix---Standard Concrete mix for use in patching operations with high early strength, designated as “High Early Patch”:

Cement Type 1— 8.62 Bag	810 lbs/cy.
Course Aggregate—Gradation D (per MoDot Sec. 1005)	1,714 lbs/cy.
Fine Aggregate—Sand	1,052 lbs/cy.
Water-	34.5 gal/cy.
Maximum Water-Cementitious Materials Ratio: 0.36	
Air Entrainment— 6% +/- 1.5% by volume at point of delivery	

- **Fly ash shall not be included in any mix design for Portland Cement Concrete Pavement without prior approval of the City Engineer.**

205.2 Cement

The cement shall meet the requirements of Standard Specifications and Tests for Portland Cement adopted by the American Society for Testing Materials (A.S.T.M.) Designation C150 Type I. The cement must be thoroughly protected against moisture, and no cement shall be

allowed to go into the work which is, in the opinion of the Engineer, injured by age or exposure. In the event cement in packages is used, no packages received in broken or damaged condition may be used.

Unless otherwise specified by the Engineer, air entraining cement shall conform to all requirements of A.S.T.M. Serial Designation C175 for Type IA Cement.

205.3 Consistency and Water-Cement Ratio

The concrete shall be mixed with a minimum amount of water that will produce a plastic, workable mix.

The consistency of the concrete shall be such that its slump shall not exceed three (3) inches plus or minus one (1) inch in slump test, Standard Method of Slump Test for Consistency of Portland Cement Concrete, A.S.T.M. Designation C143.

After the amount of water required to produce concrete of the required consistency is determined, the water measuring device on the mixer shall be set to automatically maintain the amount of water per batch. Changes in the amount of water added at the mixer shall be made whenever necessary due to changes in the moisture content of the aggregates. Moisture content of aggregates shall be recorded at the batch plant. Moisture content of aggregates shall be noted on batch tickets at least once per job, but not less than once for every 1000 cubic yards of concrete delivered to the job site.

In no case shall the amount of water used, including the amount of water contained in the aggregates, exceed five (5) gallons per sack of cement used as per Section 205.1(a) for a maximum W/C ratio of forty-five hundredths (0.45) or forty-five percent (45%).

205.4 Air Entrainment

All concrete shall have six percent (6%) air by volume with a one and one-half percent (1½%) operating tolerance as delivered to the site prior to placement.

There shall be no intentional deviation from the designated air content.

To avoid wide fluctuations in air content, the contractor shall maintain close control over uniformity of cement, aggregates, consistency of the concrete, operation of proportioning and mixing equipment, and mixing time. Air entrainment shall be obtained by use of an approved air-entraining agent added in the quantity required to obtain the designated air content, or Type IA Cement per Section 205.2. It shall be the contractor's responsibility to determine and use the quantity of agent necessary to obtain the designated air content within the permitted operating tolerance.

Air-entraining agent shall be added to the concrete during the process of mixing. The agent shall be of such volume and strength that it can be accurately measured and dispensed by means of an approved mechanical dispenser which will gradually discharge the required quantity

of material into the stream of mixing water. The entire quantity of air-entraining agent shall be fully discharged before all of the mixing water has entered the drum of the mixer. The device shall be so arranged that the flow of air-entraining agent will be automatically stopped when the required quantity has been delivered. The dispenser shall be so constructed that it can be accurately calibrated at various settings and shall be provided with means by which the discharge can be readily diverted from the stream of mixing water to a container for measurement. The dispenser shall consistently deliver the required quantity of agent within a tolerance of plus or minus three percent (3%).

205.5 Proportions

Volumes of aggregates herein set out refer to dry, rodded volumes measured as set out in Standard Method of Test for Unit Weight of Aggregate A.S.T.M. Designation C29. In proportioning materials in the field of work such quantities of aggregates must be used as will in their field condition be equivalent of the quantities required in the dry, rodded state.

The concrete shall be mixed in the proportions of one (1) sack (94 pounds net of Portland Cement) to not less than one and three-fourths ($1\frac{3}{4}$) cubic feet and not more than two (2) cubic feet of fine aggregate, and not less than three (3) cubic feet and not more than three and one-half ($3\frac{1}{2}$) cubic feet of coarse aggregate. Stated otherwise, the volumes of the combined aggregates measured separately shall not be less than four and three-fourths ($4\frac{3}{4}$) cubic feet and not more than five and one-half ($5\frac{1}{2}$) cubic feet for each sack of cement used.

The finished concrete shall contain not less than six and thirty-five hundredths (6.35) sacks of portland cement per cubic yard.

The proportions of fine and coarse aggregate may be varied within the above limits providing that the resulting mix shall be dense, plastic, well balanced, and workable; also, providing that the finished concrete shall contain not less than six and thirty-five hundredths (6.35) sacks of cement per cubic yard and that the amount of mixing water per sack of cement shall not exceed that specified.

The mix to be used on any particular job shall be determined at the beginning of the work and maintained throughout the work, only such changes being allowed as may be rendered necessary by changes in the character of the aggregates.

No aggregate will be allowed to be deposited upon the ground and any material that has come in contact with the ground shall not be used.

Aggregates shall be proportioned by weight. Such amounts of fine and coarse aggregate as will be equivalent of the required volumes of dry, rodded aggregates shall be weighed separately. Scales for weighing aggregates must be standard and correct, and the exact amount of aggregate must be weighed for each batch. Bulk cement when used shall be weighed on a separate scale.

Trucks or other conveyances used to haul aggregates that have been weighed shall be

constructed so as not to leak or lose material en route. Trucks hauling more than one (1) batch per load must be so constructed that in dumping any one (1) batch into the skip of the mixer no material is spilled from other batches on the truck. Trucks that do not fill this requirement shall not be used on the work.

The selections of the mix to be used in the work and the proportioning and weighing of aggregates and all operations connected therewith shall be made in conjunction with the Engineer and subject to his approval. All necessary tests to determine moisture content of aggregates and the required weights of aggregates in field condition to equal the volumes of dry, rodded aggregates upon which the mix will be based, and any other necessary tests on materials will be made by the Producer.

205.6 Mixing

There shall be an accurate device for measuring water and for readily discharging the required amount into the mixer.

The materials shall be mixed in a batch mixer approved by the Engineer, and irrespective of the size of the batch and the rate of speed used, the mixing shall continue after all the materials and not less than sixty percent (60%) of the water are in the drum for at least one (1) minute before any part of the batch is discharged from the drum. The drum shall be completely emptied before receiving materials for the succeeding batch. The drum should revolve at the particular speed specified for the particular mixer used, but not less than twelve (12) revolutions per minute. The volume of the mixed aggregates per batch shall not exceed the manufacturer's rated capacity of the drum in cubic feet of mixed material. The mixing shall in any case continue until the cement is uniform in color and homogeneous. The mixer shall be equipped with an instrument for measuring the time of mix, with automatic locking device which prevents discharge of concrete until mixing interval is complete.

205.7 Central Mixed and Ready Mixed Concrete

If central or transit mixed concrete is used, the contractor shall meet the following additional requirements:

Unless storage facilities permit separate storage for aggregates and cement which have been approved at the source, the contractor shall advise the Engineer of his intention to furnish central or transit mix concrete sufficiently far in advance to permit inspection and approval of all the materials.

Central mixed concrete shall be completely mixed in a stationary mixer in accordance with the requirements set out above and shall be transported to the point of delivery in a truck mixer operating at agitating speed or a truck agitator to prevent segregation while in transit to destination, except as otherwise permitted in the specifications. Under certain conditions, specified herein, non-agitating equipment may be permitted.

Transit mixed concrete shall be produced by combining the aggregates, cement, and

water in a thoroughly mixed and uniform mass in a truck mixer. The mix design shall be filed with the Engineer for the work, and the mix design shall be noted on delivery tickets.

The truck mixer shall consist of closed watertight revolving drum suitably mounted and fitted with adequate blades, or a watertight container equipped with a removable cover suitably mounted and fitted with adequate blades. Truck mixers shall be capable of combining aggregates, cement, and water into a thoroughly mixed and uniform mass of concrete and discharging the concrete without segregation. The truck agitator shall consist of a closed watertight, revolving drum or a watertight container equipped with a removable cover suitably mounted and fitted with adequate revolving blades. Truck agitators shall be capable of transporting and discharging the concrete without segregation.

In order to check the uniformity of discharge of truck mixers or agitators, the Engineer may, from time to time, make slump tests of individual samples taken at approximately the one-fourth (1/4) and the three-fourth (3/4) points of a load; and if the slumps differ by more than two (2) inches per 205.1(a), that mixer or agitator shall not be used unless the condition is corrected, except that the equipment may still be used if operation with a longer mixing period or with a smaller load will permit this requirement to be met.

When used for truck mixing, the capacity of truck mixers shall be in accordance with the manufacturer's rating, but the volume of mixed concrete shall not exceed fifty-seven and five-tenths percent (57.5%) of the gross volume of the drum or container. When used for agitating, the capacity of the truck mixer or truck agitator shall be in accordance with the manufacturer's rating, but the volume of mixed concrete shall not exceed eighty percent (80%) of the gross volume of the drum or container.

Each truck mixer or agitator shall have attached thereto, in a prominent place, a metal plate or plates on which is plainly marked by the manufacturer the various uses for which the equipment is designed, the capacity of the drum or container in terms of the volume of mixed concrete and the speed or rotation of the mixing drum or blades. When capacities less than the limits indicated in this section are shown on the metal plates, it indicates the maximum capacities for which the equipment was designed to be operated under the conditions stated by the manufacturer, and such capacities shall govern.

Truck mixers and agitators shall be operated at the speed of rotation designed by the manufacturer of the equipment, provided such speeds are within the following limits. Mixing speed for the revolving drum type of mixer shall not be less than four (4) revolutions per minute of the drum, not greater than a speed which will produce a peripheral velocity of the drum of two hundred twenty-five (225) feet per minute. For the revolving blade type of mixer, speeds shall not be less than four (4) nor more than sixteen (16) revolutions per minute of the mixing blades. Agitating speed for both the revolving drum and the revolving blade types shall not be less than two (2) nor more than six (6) revolutions per minute of the drum or of the mixing blades.

Transit mixed concrete shall be mixed not less than fifty (50) and not more than three hundred (300) revolutions of the drum or blades at mixing speed after all of the ingredients, including water, are in the mixer. When a truck mixer or truck agitator is used for transporting

concrete that has been completely mixed, agitation of the concrete shall continue during transportation at the speed designated by the manufacturer of the equipment as agitating speed. Truck mixers shall be equipped with a means by which the number of revolutions of the drum or blades may be readily verified.

Water measuring equipment shall meet the requirements set out above. If mixing water is to be added while the concrete materials are in transit, the truck mixer shall be equipped with a tank for carrying mixing water, the water to be measured and added to the tank at the proportioning plant unless the tank is equipped with an automatic measuring device. When wash water is used as a portion of the mixing water for succeeding batches, it shall be accurately measured and taken into account in determining the amount of additional mixing water required. If the mixer is not equipped with an automatic water measuring device, a calibrated tank shall be installed either on the trucks or at the job site for measuring water to be used to obtain satisfactory workability in case of extremely dry batches. Forty (40) revolutions of the drum or mixing batches shall be required after adding additional water to improve the workability, and the water which is added to the mixed concrete at the site of the work shall be noted on the delivery ticket and be included in determining the net water.

Central or transit mixed concrete shall be delivered to the site of the work and discharge shall be complete within one and one-half (1½) hours after the introduction of the mixing water to the cement and aggregates or the introduction of the cement to the aggregate. In hot weather, or under conditions contributing to quick stiffening of the concrete, a time less than one and one-half (1½) hours may be specified by the Engineer. When a truck mixer is used for transit mixing of the concrete, the mixing operation shall begin within thirty (30) minutes after the cement has been added to the aggregates.

Watertight covers shall be used to cover the containers of open top mixers and agitators when the length of time from the addition of water to the cement and aggregates to the discharge of the concrete exceeds fifteen (15) minutes.

Central mixed concrete may be transported in non-agitating equipment at the discretion of the Engineer, if the length of haul is less than one (1) mile and only a small quantity of concrete is involved. The bodies of non-agitating equipment shall be smooth watertight containers equipped with gates that will permit control of the discharge of the concrete. Watertight covers shall be provided for protection of the concrete. The concrete shall be delivered to the site of the work in a thoroughly mixed and uniform mass and discharged with a satisfactory degree of uniformity. Slump tests of individual samples taken at approximately the one-fourth (1/4) and three-fourths (3/4) points of the load during the discharge shall not differ more than two (2) inches. The discharge of the concrete transported in non-agitating equipment shall be completed within forty-five (45) minutes after the introduction of the mixing water to the cement and the aggregates. When hauling heated concrete or under other conditions contributing to quick stiffening of the concrete, a time less than forty-five (45) minutes may be specified.

In case air-entraining concrete is used, the above limits of haul distance, time, and quantity of concrete may be increased by the Engineer in the plans and specifications for a

specific project, provided the concrete when delivered to the work complies with the requirements specified herein.

205.8 Retempering

Retempering of mortar or concrete that has partially hardened; that is, remixing with or without additional materials or water, will not be permitted.

205.9 Record of Cement Used

In order to keep a check on the amount of cement used in the concrete and to determine whether this amount conforms to the minimum amount allowed six and thirty-five hundredths (6.35) sacks per cubic yard of concrete, the Engineer will keep a record of the cement used throughout the work. The contractor shall furnish such assistance as may be needed to enable the Engineer to determine accurately the amount of cement used.

205.10 Forms

Where combined curb and gutter exists or are constructed as part of the improvement these shall be used as the side forms for the concrete slab. Where there are no gutters, the line and grade of the slab shall be governed by a line of forms set along each side of the pavement. Where a longitudinal construction joint is required, an additional form will be necessary. Forms shall be rigidly staked to the exact line and grade therefor so as to provide an accurate track for the mechanical finishing machine or vibrating screed. Steel forms are preferred. If wooden forms are used, they shall not be less than two (2) inch stock and shall be straight and free from warp. All forms shall be cleaned and oiled before being used. Forms shall be placed on compacted granular base per Section 202.

205.11 Placing Concrete

Contractor shall notify the Engineer at least twenty four (24) hours prior to the start of placing concrete. Prior to placing the concrete, the granular base shall be brought to an even, well compacted surface that varies by no more than one (1) inch of the required grade. Subgrade and granular base must have been approved by Engineer prior to notice to proceed with placement of concrete.

The surface of the granular base shall be thoroughly wetted but shall show no pools of water when the concrete is placed. When required by the Engineer, the granular base shall be wetted the night prior to concrete placement that is to begin early the next morning.

After mixing, the concrete shall be deposited rapidly upon the granular base to the required depth and for the entire width of the slab in successive batches and in a continuous operation without the use of intermediate forms or bulkheads between expansion joints. Where the grade is greater than six percent (6%), the concrete shall be placed and finished proceeding uphill unless written approval for an alternate procedure is obtained from the City Engineer prior to bidding a specified job.

The concrete shall be placed with a minimum of rehandling to avoid segregation. No concrete that has partially hardened or has been contaminated by foreign material shall be deposited on the work, nor shall re-tempered concrete be used. Concrete shall be thoroughly vibrated along the forms or sides and along expansion and key type longitudinal joints by means of a small approved hand-type mechanical vibrator. Care shall be taken that the vibrator does not penetrate the subgrade, contact reinforcement, or dislodge or remove the joints. Vibration shall not be utilized as a means to move concrete.

When a center contraction joint is called for, the Engineer may direct that only half the width of the pavement shall be paved in one operation.

Placing of concrete shall stop sufficiently in advance, so that all finishing required may be accomplished in full daylight.

Placing of concrete for curbs will be made as close behind placement of concrete for the slab as is practical, and as directed by the Engineer.

205.11(a) Cleanout and Washout Facility

Any concrete in excess of that required to complete a section at the stopping of the work shall not be used. The contractor shall be responsible for providing washout facilities that will contain all excess concrete and wash water from delivery vehicles, tools, etc... Excess concrete and wash water shall not be deposited upon the ground or pavement such that it could become mixed with stormwater per the applicable City ordinances and Stormwater Management Plan.

205.12 Slip Form Paver

In lieu of the construction methods heretofore described, the contractor may use a slip-form paver. When the slip-form paver is used, all reference in the preceding sections of this specification referring to forms shall be deleted.

Slip-form pavers shall be equipped with vibratory assemblies, which are effective over the full width of the pavement. The paver shall also have a metal float with a full nosed front end for the full width of the pavement, excluding curbs, which will extrude the concrete under pressure.

The curb shall be formed by extrusion plates or mules mounted on the machine.

Subgrade shall be brought to the proper grade and cross section by means of a properly designed and operated machine. The subgrade shall comply with applicable sections of the specifications. If any traffic is allowed to use the prepared subgrade, some device, satisfactory to the Engineer, shall be provided for checking and correcting the subgrade prior to the beginning of placing the concrete. The subgrade work, especially the path on which the tracks of the paver ride, must be done carefully and accurately as its degree of precision greatly affects the resulting smoothness of the pavement surface.

Concrete shall be of uniform slump and adequately supplied in front of the paver. The rate of progress shall be controlled so that the forward movement of the paver will be as nearly continuous as practicable. If it is necessary to stop the forward movement of the paver, the vibrator element shall also be stopped immediately. Care must be taken to see that a sufficient supply of concrete passes around the float along the form line to form the integral curb, where shown on the plans.

Final finishing operations shall conform to the standard specifications. The curb shall have the same final finish as the pavement.

Surface tolerance of the pavement shall be one-fourth ($\frac{1}{4}$) inch in ten (10) feet on residential and collector streets as checked with a ten (10) foot straight edge and one-eighth ($\frac{1}{8}$) inch in ten (10) feet on arterial streets when checked longitudinally with a ten (10) foot straight edge. Profilographing per Section 502.8 of the Missouri Standard Specifications for Highway Construction (2004) may be utilized on collector or arterial streets as specified in the project special conditions by the Engineer.

205.13 Consolidation and Finishing

The pavement shall be struck off and consolidated with mechanical finishing machine or by hand finishing methods. When a mechanical finishing machine is used, the concrete shall be struck off at such a height that after consolidation and final finishing it shall be at the elevations as shown on the plans. A depth of excess concrete shall be carried in front of the strike off screed for the full width of the slab, whenever the screed is being used to strike off the pavement.

The finishing machine shall be provided with a screed, which will consolidate the concrete by pressure and, or vibration. The concrete shall, through the use of this machine, be brought to a true and even surface, free from rock pockets, with the fewest possible number of passes of the machine. The edge of the screeds along the curb line may be notched out to allow for sufficient concrete to form the integral curb. Hand finishing tools shall be kept available for use in case the finishing machine breaks down. When hand finishing is used, the pavement shall be struck off and consolidated by a vibrating screed or other approved equipment to the elevation shown on the plans. The vibrating screed must be approved by the Engineer, prior to placement of concrete. When the forward motion of the vibrating screed is stopped, the vibrator shall be shut off and not be allowed to idle on the concrete. Internal mechanical vibration shall be used alongside all formed surfaces and reinforcement as per Section 205.11. Vibration operation shall be completed prior to final hand finishing.

205.13(a) Floating, Surfacing, and Edging.

After the concrete has been struck off and consolidated, it shall be further smoothed by means of a wood or aluminum float at least five (5) feet wide with a handle long enough to reach the entire width of the slab being placed. The float shall be operated so as to remove any excess water and laitance, as well as surface irregularities. After the floating operation, the pavement surface should be within the specified tolerances. While the concrete is still plastic, the slab

surface shall be tested for smoothness with a ten (10) foot straightedge swung from handles three (3) feet longer than one-half the width of the slab. The straightedge shall be placed on the surface parallel to the centerline of the pavement and at not more than five (5) foot intervals transversely. After each test, the straightedge shall be moved forward one half its length and the operation repeated. When irregularities are discovered, they shall be corrected by adding or removing concrete. All disturbed places shall again be floated as above and again straightedged. The pavement surface shall have no depression in which water will stand. Before final finishing is completed and before the concrete has taken its initial set, the edges of the slab and curb shall be carefully finished with an edger of the radius shown on the plans if so specified.

205.13(b) Final Surface Finish

A broom finish shall be used as the final finishing method. A hard bristle broom shall be used, which shall be kept clean and used in such a manner as to provide a uniform texture surface. The curb shall have the same final finish as the pavement. The final surface of the concrete pavement and curb shall have a uniform gritty texture free from excessive roughness and true to the grades and cross section shown on the plans. The Engineer may require changes in the final finishing procedure as required to produce the desired final surface texture.

Care shall be taken in vibrating and floating the pavement not to move or displace expansion joints and special care be taken to secure a smooth, continuous grade over the expansion joints.

The finished surface of the slab shall not vary more than one-fourth (1/4) inch from any specified contour, and shall be free from depressions or inequalities of any kind. When the finished surface does not meet these requirements it shall be corrected even to the extent of repeating the entire floating and finishing operations.

205.14 Curing and Protection

After the placing and finishing operations on the pavement are completed, it shall be treated by one of the following methods for the purpose of curing:

Sprayed-on white pigmented liquid membrane compound, wet burlap or cotton mats, or waterproof plastic sheets. Whatever method is used it shall be started as soon as water sheen disappears from the concrete surface and shall be applied in such a manner that it does not mar the pavement surface. After the pavement forms are removed the edges of the slab must also be cured, and the trench excavated for the forms shall be entirely backfilled so that no water will be allowed to stand next to the pavement.

205.14(a) Liquid Curing Compound

Liquid curing compound shall be a Water-Base, Wax-Base, White Pigmented, Non-Yellowing Concrete Curing Compound conforming to Specifications for Liquid Membrane Forming Compound for Curing Concrete A.S.T.M. C309, Type 2, Class A.

Where liquid curing compound is used it shall be placed after the concrete is finished and the free water has left the surface. The entire area of the pavement surface shall be sealed by hand or machine spraying thereon a uniform application of the membrane curing solution. The solution shall be applied in one (1) or two (2) separate applications as may be recommended by the manufacturer and as directed by the Engineer. If the solution is sprayed in two (2) applications, the second application shall be made within thirty (30) minutes. Satisfactory coverage shall be construed as total coverage, such that none of the concrete surface is left uncovered or is visible through the white pigmented liquid curing compound.

The contractor shall provide satisfactory equipment and means to properly control and assure the direct application of the curing solution on the pavement surface so as to result in a uniform coverage on the pavement at the rate of at least one (1) gallon for each one hundred fifty (150) to two hundred (200) square feet of area, depending upon weather conditions and manufacturer's recommendations.

Satisfactory equipment and means to control and apply the curing solution shall be construed as being whatever appliances and methods are needed to prevent the loss of any solution during the application; also, an approved means of measuring the quantity to be applied.

If rain falls on the newly coated pavement before the film has dried sufficiently to resist damage, or if the film is damaged in any other way, the contractor will be required to apply a new coat of material to the affected portion equal in curing value to that above specified. All areas cut by finishing tools subsequent to the application of the curing solution shall immediately be given new applications at the rate specified above.

The contractor shall provide on the job sufficient plastic sheeting for the protection of the pavement in case of rain or breakdown of spray equipment. In the event that hair-checking develops before the membrane can be applied, the contractor shall place and keep moistened a burlap covering or plastic sheeting, all as directed by the Engineer.

205.14(b) Wet-Burlap or Cotton Mats

Where mats are to be used, they shall be placed as soon as it is possible to do so without marring the surface, but not before the water sheen has disappeared. The mats shall be inspected for rips and holes that would permit loss of moisture, and shall be clean and wet when placed. They shall be large enough to cover the surface and edges of the slab and shall be overlapped several inches. The mats should be held in position by mounds of earth, sand, lumber, or other weights along the pavement edges and must be kept wet. Cotton mats shall conform to A.S.T.M. C440 and burlap mats shall conform to AASHO M182.

205.14(c) Waterproof Plastic Sheets

Where waterproof plastic sheets are placed for curing they shall meet requirements for placing mats except waterproof plastic sheets shall conform to AASHO M171 specification.

205.15 Weather Conditions

205.15(a) Cold Weather

Except when specifically permitted by the Engineer, placing of concrete shall not be permitted when the descending air temperature in the shade falls below forty degrees (40°) Fahrenheit. When concreting is permitted during cold weather, the temperature of the mixed concrete shall be not less than sixty degrees (60°) Fahrenheit nor more than one hundred degrees (100°) Fahrenheit at the time of placing in the forms. The aggregates may be heated by steam or dry heat until free of all ice and frost prior to being placed in the mixer. The water shall not be hotter than one hundred seventy degrees (170°) Fahrenheit. When concrete is being placed during cold weather and the air temperature may be expected to drop below thirty-five degrees (35°) Fahrenheit, a supply of straw and plastic to cover the straw, or other suitable blanketing material shall be in place along the line of the work before the work may proceed. Care must be exercised to prevent the wind from removing same. At any other time when the air temperature may be expected to reach the freezing point during the day or night within three (3) days (72 hours) of placement of the concrete, or for as much time as is necessary to ensure proper curing of the concrete, the material so provided shall be spread over the concrete to a sufficient depth to prevent freezing of the concrete. Such protection shall be maintained for at least five (5) days. If required by the Engineer, concrete less than twenty-four (24) hours old shall also be covered by approved devices capable of maintaining the temperature within the concrete at fifty degrees (50°) Fahrenheit or higher. Concrete injured by frost action shall be removed and replaced at the contractor's expense.

In no case may concrete pavement be placed on frozen subgrade or base material. In no case may concrete pavement be placed when air temperature is thirty two degrees (32°) Fahrenheit and below. No concrete may be placed on a bridge super structure when the air temperature is less than forty degrees (40°) Fahrenheit.

The cost of providing the heated concrete and its protection as outlined above shall be completely covered by the unit price bid for P.C. Concrete Pavement.

205.15(b) Rain and Inclement Weather

Concrete pavement shall not be placed when rain is falling or imminent. Paving when climatic conditions are unstable is up to the Contractor, but may be prevented by the Engineer. If climatic conditions change during paving, the Contractor shall stop paving and arrange for sufficient plastic sheeting to cover all newly placed concrete that has not hardened sufficiently to prevent denting of the surface. All plastic sheeting shall be sufficiently weighted to prevent them from blowing in the wind. The Contractor shall be held responsible for all curing and finishing operations required by these specifications. The application of dry cement shall not be an acceptable method of removing excess water from the surface of wet concrete pavement.

If rain is sufficiently heavy and occurs soon after concrete placement, such that surface mortar damage occurs due to increased water-cement ratio, corrective action shall be taken to the extent of diamond grinding the surface to remove the non-durable top surface. Diamond

grinding can only be performed where pavements will meet the minimum thickness requirements when completed. Grinding shall not commence before the pavement has reached the strength specified for opening to traffic.

The Contractor shall be responsible for all testing required to determine that concrete pavement will be durable in terms of abrasion, skid resistance, or freezing and thawing. Surface scaling testing may be conducted in accordance with ASTM C 672. In extreme cases, petrographic analysis shall be conducted prior to diamond grinding to determine the extent of damage and determine the concrete's water-cement ratio, air content, air-void spacing factor, and general appearance using ASTM C 856. If the general petrographic analysis is inconclusive, a more detailed examination of the air-void system using ASTM C 457 shall be performed. Rain damaged concrete pavement shall be removed when it is shown to be substandard.

205.15(c) Hot and/or Dry Weather

Additional precautions shall be taken when temperatures are generally above ninety degrees Fahrenheit (90°F), relative humidity is low, or wind speeds are high with sunny conditions. When hot and/or dry weather conditions exist, paving shall be performed in early morning and late evening when possible. Base, forms, and tools shall be kept damp, but not wet to point of changing the water-cement ratio of the concrete. Curing compound shall be applied as soon as possible and additional curing compound may be required under these conditions.

Uniform moisture shall be maintained in aggregate stockpiles and set retarders may be required to slow hydration. Because setting will occur more rapidly under these conditions, paving shall only proceed at a pace that finishing and sawing operations can be completed as required. Additional manpower and equipment may be required to complete finishing and sawing tasks under these conditions.

Paving under hot and/or dry conditions may not be allowed to begin unless the Engineer agrees that Contractor has taken precautions to prevent problems from occurring due to these conditions. Shrinkage cracking, surface crazing, insufficient or incomplete finishing operations, and other defects may develop due to hot and/or dry conditions. Pavement damaged by hot and/or dry conditions may be required to undergo testing and/or remediation as outlined in 205.15(b).

205.16 Reinforcing Steel Bars

The type of steel used for reinforcement and tie bars shall be a deformed bar the least cross sectional area of which shall be equal to that of the bar of required size, and shall develop an ultimate adhesive or mechanical bond of three hundred (300) pounds per square inch of surface. The physical properties of the steel shall conform to the following:

All reinforcement steel shall be Grade Forty (40). The bar shall bend cold one hundred eighty degrees (180°) around a pin of a diameter three (3) times the thickness of the bar, without fracture on the outside of the bend. The bars shall be from standard section tee rails or from billets.

Payment for reinforcing steel bars will be made at the unit price bid for the steel reinforcing bar of the designated diameter per lineal foot, furnished in place in the work, including metal supports for securing the bar firmly in place.

205.17 Protection of Slab at Intersecting Streets

Where P.C. Concrete Pavement will join streets or alleys having other than the same type pavement, or unimproved streets, a Type E joint shall be constructed. The pavement shall be thickened a minimum of two (2) inches over a distance of at least five (5) feet. Where P.C. Concrete Pavement meets asphalt pavement, a one (1) inch thick strip of expansion joint material per Section 205.19(a) shall be inserted before the terminating form. Where P.C. Concrete Pavement meets aggregate pavement, a timber header two (2) inches by ten (10) inches minimum dimensions, of oak or other approved lumber, with a dovetail or keyed yoke joint, securely pinned, and left in place. Any slot left between a concrete pavement and adjoining asphalt pavement shall be filled with asphaltic concrete to provide a suitable riding surface, all as directed by the Engineer.

Cost of providing the timber header and placing of asphalt filler as above described shall be completely covered by the unit price bid for P.C. Concrete Pavement.

205.18 Opening to Traffic

P.C. Concrete Pavement or driveways shall not be opened to low volume, light traffic or to the contractor's equipment for a period of seven (7) days after placing the concrete pavement, or until it can be verified by cylinder-break tests that the pavement has reached a compressive strength of three thousand five hundred (3,500) psi, or such length of time as may be specified or directed by the Engineer.

P.C. Concrete Pavement shall be shown to have reached a minimum compressive strength of four thousand (4,000) psi prior to being opened for all types of traffic.

The contractor shall maintain adequate barricades and protection to the pavement in compliance with the most recent edition of the Manual on Uniform Traffic Control Devices to prevent traffic from using the pavement for the length of time specified herein. Barricades shall be of the permanent type set on posts anchored in the ground, or of such a weight that they are not readily movable by hand. Portable blinking barricades by themselves are not considered sufficient barricades.

205.19 Joint Construction

205.19(a) Transverse and Expansion Joints

Transverse joints, not less than one (1) inch in thickness shall be inserted perpendicular to the surface of the pavement and at right angles to the axis thereof, at radius points of intersections, beginnings and endings of horizontal curves, and on tangents at intervals not to

exceed two hundred fifty (250) feet, or as otherwise shown on the plans or ordered by the Engineer, provided however, that no section between joints shall be less than twenty-five (25) feet in length. All catch basins, manhole tops, poles and other fixed objects which project through the pavement shall be separated from the concrete by an expansion joint of not less than three-fourths (3/4) inch.

All joints shall be formed by inserting during construction and leaving in place the required thickness of prepared strips of material meeting Standard Specifications for Preformed Expansion Joint Fillers for Concrete, non-extruding and resilient types A.S.T.M. Designation D1751 (AASHTO M213). Joints shall extend the full width and depth of the slab. Expansion joints shall be sealed with a specific filler per 205.19(e).

Expansion joints shall be fitted with five eighths (5/8) inch round smooth steel rods for six (6) inch streets, and three-fourths (3/4) inch smooth round steel rods for seven (7) inch and eight (8) inch streets, spaced eighteen (18) inches center to center, eighteen (18) to twenty-four (24) inches long as set out on the plans or as directed by the Engineer, the rods are to be fitted with metal or plastic sleeves, punched or molded so as to stop the rod to provide a three-fourths (3/4) inch space at the end of the cap and crimped to prevent any foreign material from entering the sleeve. Half of each rod is to be well greased with graphite grease or heavy oil. The sleeve is to be placed on the well greased end of the rod and the rod supported firmly with approved metal basket assembly or ties to the granular base or subgrade as necessary. The greased sleeves are to be placed on alternating ends of adjacent reinforcement rods within a joint.

205.19(b) Contraction Joints

All joints in the pavement not made by forms shall be sawed. Such joints shall be cut by means of an approved concrete saw to a depth of one-third (1/3) of pavement thickness and shall continue through the edge of the slab or curb. Sawed joints that do not continue at the specified depth all the way through the curb or slab edge will be rejected.

The saw shall be equipped with a suitable guide, properly adjusted so there will be no side sway, and the joint shall be cut in a straight line. During the sawing the blade shall be cooled and lubricated abundantly with cool water, and used in accordance with the manufacturer's recommendations.

Joints shall be sawed unless the plans, or the Engineer, definitely state otherwise. The joints shall be sawed after the concrete has set sufficiently to prevent raveling, but early enough that shrinkage stress has not caused the formation of early cracks. Following sawing, the joints shall be cleaned and sealed with a specified filler per Section 205.19(e).

Where approved by the Engineer, contraction joints may be skewed with the center line. Maximum skew shall be five (5) feet for thirty (30) feet of joint length. Skew shall be in direction of traffic flow.

All joints in P.C. Concrete Pavement shall be of the type and dimensions shown on the plans. Unless otherwise shown on the plans or as directed by the Engineer, the transverse joints

shall be at twelve (12) foot intervals for six (6) inch streets and fifteen (15) foot intervals for seven (7) inch or eight (8) inch streets as measured along the center line.

All saw constructed longitudinal joints shall, unless otherwise ordered by the Engineer, be provided with steel tie bars five-eighths (5/8) inch in diameter, two and one-half (2 1/2) feet long, spaced at two and one-half (2 1/2) foot intervals. Such bars shall be set in a plane one-half (1/2) the thickness of the pavement and secured by metal supports to the subgrade.

205.19(c) Construction Joints

Transverse construction joints shall be placed where ever continuous pouring of the street slab is interrupted for thirty (30) minutes or more, at the end of the day's pour or at the end of construction when not tied to an existing street. The joint will be formed by placing a two (2) inch thick wooden header or other form material acceptable to the Engineer. The header shall be removed before continuing a pour.

Wherever possible, construction joints shall be placed at a contraction joint location. But in no case shall a construction joint be closer than ten (10) feet from any other transverse joint. At all other locations, construction joints shall be reinforced the same as expansion joints. Before work continues the reinforcing bars shall be lubricated and capped as per expansion joints with grease and caps being placed all on the same ends.

If the construction joint is to join an existing slab, the reinforcing bars shall be epoxied into drilled holes. The exposed ends shall be supported by means of a dowel support that will stay in the pavement and ensure that the dowels are not displaced during construction.

205.19(d) Longitudinal Joints

Longitudinal joints shall be the type and at the locations as shown on the plans. They shall, unless otherwise ordered by the Engineer, be provided with deformed Grade Forty (40) steel tie bars five eighths (5/8") inch in diameter, two and one-half (2 1/2) feet long, spaced at two and one-half (2 1/2) foot intervals.

Transverse slab width between joints shall be a minimum of seven and one-half (7 1/2) feet and a maximum of thirteen (13) feet.

205.19(e) Sealing Joints

The top of expansion joints and all sawed joints and edged joints shall be sealed with a hot-poured plastic type material in accordance with the requirements of the A.S.T.M. Designation D6690 or the latest revision thereof. The packages in which the filler material is delivered shall be clearly marked to indicate the batch of which it forms a part, the recommended pouring temperature, and the safe heating temperature.

The filler shall be poured into the joint opening to conform to the details shown on the plans or as directed by the Engineer. The pouring shall be done in such a manner that the

material will not be spilled on the exposed surfaces of the concrete. Any excess filler on the surface of the concrete pavement shall be removed immediately and the pavement surface cleaned.

When required to prevent tackiness or pickup under traffic, the exposed surfaces of the filler shall be dusted with hydrated lime. Other methods of preventing pickup under traffic may be used when approved by the Engineer.

Poured fillers shall not be placed when the air temperature in the shade is less than fifty degrees (50°) Fahrenheit except by the approval of the Engineer.

205.20 Payment for Concrete Pavement Slab

Payment for P.C. Concrete Pavement shall be made at the unit price bid per square yard for this item which price shall be full compensation for all material, labor, equipment, curing, and all else necessary to furnish the pavement complete in place.

205.21 Backfilling Slab Edges and Curbs

Slab edges and the back side of integral curbs shall be banked with earth as soon as the forms are removed and the required finishing operations completed. Before the pavement is opened to traffic or the work accepted, the area outside the slab edge or back of the curb shall be backfilled with selected earth approved by the Engineer, thoroughly compacted in layers not exceeding six (6) inches in depth and neatly graded off flush with the slab or top of curb as shown in the plans. Permanent or temporary vegetation shall be established as per the City's grading and stormwater ordinances.

If erosion next to the slab edge or back of curb creates a void that extends four (4) or more inches underneath the street from the outside edge of the slab, no matter the depth, it must be filled with flowable fill consisting of equal parts sand, water, and cement under the supervision of the Engineer.

205.22 P.C. Concrete Pavement Testing and Inspection

The Contractor shall notify Engineer at least twenty-four (24) hours prior to the need for inspection services. A schedule of work shall be submitted to the Engineer for projects lasting more than forty-eight (48) hours total. The Engineer shall perform tests on the concrete as delivered to the work site for air content, slump, and compressive strength per Section 205.1(a). A minimum of four (4) cylinders shall be set aside for compressive strength testing at seven (7), fourteen (14), and twenty-eight (28) days. If cylinders are disturbed by construction or other activities it shall be reported to the Engineer. Cylinders must be protected from freezing.

A minimum of one (1) complete set of concrete tests shall be made for every day's work. An additional complete set of tests shall be made for each one hundred (100) cubic yards of concrete delivered to the work site. Additional slump and air tests only shall be taken at a minimum for every fifty (50) cubic yards delivered to the work site.

P.C. Concrete pavement found to be not in compliance with Section 205.1(a) shall be rejected. The batch ticket for that load will be taken and marked as rejected by the Engineer. The delivery vehicle shall leave the site immediately and shall not be allowed back on the work site without a new batch ticket.

When pavement cylinders do not meet the strength test requirements, the panel representing the station where the cylinder was taken, and adjacent panels on either side parallel to the centerline of the street shall be removed and replaced for the full width of the pour. Cores shall be taken from the third panel in either direction from the station at which the original cylinder test was made. Cores shall be obtained and tested per Section 205.22(a).

Initial testing required by these specifications will be performed by the City or its agent. Additional testing required due to failed tests will be billed to the developer, or to the contractor in the case of a City contract.

205.22(a) Coring of Pavement

Coring shall be performed on all new pavements to ensure minimum thickness and in-place strength requirements prior to the City's acceptance. Cores shall be neatly cut with a core drill at locations indicated by Engineer. Cores shall be taken and tested in accordance with AASHTO T 24 by a certified laboratory designated by the City. The contractor shall fill the core holes with an approved non-shrink grout within one day after sampling.

At least one core sample shall be taken for strength and thickness from each day's work, or at least one (1) core per five hundred (500) linear feet of each traffic lane, or as directed by the Engineer.

Where cores are found to be deficient in strength, the panel representing the station where the cylinder was taken, and adjacent panels on either side parallel to the centerline of the street shall be removed and replaced for the full width of the pour. Additional cores shall be taken from the third panel in either direction from the station at which the original cylinder test was made. Cores shall be obtained and tested per these specifications. It will be assumed that each core is representative of the pavement for a distance extending one-half (1/2) the distance to the next core, measured along centerline, or in the case of a beginning or ending core, the distance will extend to the end of the pavement section.

Where cores are found to be deficient in thickness, the panel representing the station where the cylinder was taken shall be removed for the full width of the pour. The edges of the panel shall be measured to determine thickness of adjacent panels. Additional cores shall be taken from the second panels in either direction parallel to the center line of the street and checked for thickness. It will be assumed that each core is representative of the pavement for a distance extending one-half (1/2) the distance to the next core, measured along centerline, or in the case of a beginning or ending core, the distance will extend to the end of the pavement section.

Initial testing required by these specifications will be performed by the City or its agent. Additional testing required due to failed tests will be billed to the developer, or to the contractor in the case of a City contract.

205.23 Pavement Repair or Replacement

Pavement found to be deficient or damaged prior to acceptance for maintenance by the City shall be replaced per the City's pavement repair and replacement policy. All damaged, cracked, or deficient panels shall be replaced in their entirety.

Street panel shall be defined as the portion of a concrete street between sawed contraction joints and/or expansion joints. Integral curbs constructed as part of the street shall be included as part of the street panel.

Replacement method and materials shall be per the City of Jackson Street Standard Specifications and other pertinent ordinances or policies. All replacement panels shall be a minimum of one inch thicker than the existing pavement. All replacement panels shall have a minimum of four (4) inches of the subgrade material removed. The remaining subgrade material shall be compacted to ninety-five percent (95%) of maximum standard density. If the remaining subgrade is questionable, it shall be inspected by the City Engineer or his representative and approved for use. If the remaining subgrade is unacceptable, it shall be removed and replaced with Type 5 base crushed rock per Section 203.2 and compacted to ninety-five percent (95%) of maximum standard density to proper grade.

Panel construction and reinforcement shall be per the Concrete Street Patch Joint Detail as approved for concrete panel repairs.

206 ONE COURSE PORTLAND CEMENT CONCRETE CURB AND INTEGRAL CURB

206.1 General

One course concrete curb and integral curb shall be built to the form and dimensions shown on the plans.

206.2 One Course P.C. Concrete Curb

One course curb shall be made of concrete meeting all the requirements of the concrete specified for Section 205 (Portland Cement Concrete Pavement Slab).

It may be built either before or after the construction of the pavement slab at the option of the Engineer.

Forms for one course curb shall be constructed accurately and rigidly to the required cross section and line and grade. Forms shall be straight and free from warp. They shall be of not less than two (2) inch stock when wooden forms are used and they shall be rigidly staked to the established line and grade. The erection of forms must be kept one (1) block ahead of the pouring of concrete. Under no condition is the placing of concrete to be undertaken while the forms are under construction. No concrete shall be deposited into forms until the forms have been inspected for line, grade, and correctness by the Engineer. No forms shall be removed from the work the same day the concrete is poured into them except by special permission of the Engineer.

Forms shall be cleaned and oiled before the concrete is placed.

Concrete shall be cast to the required form in one (1) pouring without requiring plastering after the removal of the forms. The concrete shall be poured of such consistency that it will with proper working produce a smooth, dense surface along the forms. The top surface of the curb shall be floated to a smooth plane and the top edges rounded as required. All formed surfaces shall be carefully spaded and worked to eliminate all honeycombing and roughness.

Transverse expansion joints three-fourths (3/4) inch wide composed of approved non-extruding material shall completely divide the curb at points opposite the expansion joints in the concrete slab. The lengths of curbing between expansion joints shall be reinforced with steel as provided for on the plans. A one-half (1/2) inch precast asphalt joint shall separate the curb from the concrete slab.

206.3 P.C. Integral Curb

Integral curb shall be built of concrete meeting all the requirements of the concrete specified for the P.C. Concrete Pavement slab in Section 205, and in the same manner as the one course curb, Section 206.2, except that it shall be built integral with the concrete pavement. It must be cast immediately after the concrete slab is poured and while the latter is still soft, moist

and adhesive so that it will set as an integral mass with the pavement slab.

Transverse expansion joints one (1) inch wide and composed of approved non-extruding material shall be installed so as to form a continuation of the joints in the slab.

Forms for the integral curb shall be constructed accurately and rigidly to the required cross section and line and grade. After the concrete has been deposited into the forms and has set sufficiently to permit their removal, the curb shall be finished by hand and to the final required shape and then neatly brushed in a transverse direction to a smooth neat finish.

All provisions for curing and protection and all requirements governing aggregate proportioning, mixing and handling, as set out under Section 205 (Portland Cement Concrete Pavement Slab), shall apply to the concrete of the one course and integral curbs. Openings through the curb for roof drains or other stormwater appurtenances shall not be provided unless specifically approved by the Engineer.

206.4 Payment for P.C. One Course Concrete Curb and Integral Curb

The contract price for one course or integral curb shall cover and include the cost of all material, labor, and equipment and be full compensation for furnishing same complete in place, including excavation, accessories, incidentals and openings through curb for roof drains. This price shall cover both the straight and curved work.

207 MISCELLANEOUS REQUIREMENTS APPLICABLE TO ALL STREET IMPROVEMENTS

207.1 General

The contractor shall remove and replace all mail boxes, street and traffic signs, pipe for driveways or across the street, in a careful manner to salvage same. If, in the opinion of the Engineer, the contractor shall damage any of the foregoing items, he shall at his expense replace same with like material and of a quality equal to that prior to damage. Any pipe so removed, which is not to be replaced shall become the property of the City, or the adjoining property owner, as the case may be.

207.2 Payment for Miscellaneous Requirements

The cost of the work above described shall be completely covered by the prices bid for other items in the contract.

208 PORTLAND CEMENT CONCRETE SIDEWALKS

208.1 Description

Concrete sidewalks shall be constructed to the line, grade, and dimensions shown on the plans or as established by the Engineer.

Concrete sidewalks shall be required on all new residential subdivisions and commercial buildings where lots front a public street. The minimum width of the sidewalks shall be four (4) feet in residential areas and six (6) feet in commercial areas. The minimum thickness of a sidewalk shall be four (4) inches with a four (4) inch compacted stone base. Where the sidewalk is used as a part of driveway, it shall be a minimum thickness of six (6) inches with a four (4) inch compacted stone base. Driveway crossings shall maintain a two percent (2%), or one-fourth (1/4) inch in one (1) foot cross slope.

Where replacing an existing sidewalk, the contractor shall construct the new sidewalk to the width, grade, and line of the old sidewalk, or as otherwise designated by the Engineer.

208.2 Materials

Regular Concrete as specified in Section 205 shall be used for all sidewalk construction.

- Any variation or additions to the concrete mix must be approved by the City Engineer.

Stone Base: The four (4) inch stone base shall be type five (5) stone with a maximum size of three-quarter (¾) inch or clean sand, compacted to 85% Standard Proctor Density.

208.3 Mixing Concrete

The Contractor shall use plant mixed concrete whenever feasible, and under no circumstances shall mix concrete otherwise, unless authorized to do so by the Engineer.

208.4 Construction Methods

- A. Subgrade- The concrete sidewalk shall be constructed on a prepared smooth subgrade of uniform density thoroughly compacted by rolling or tamping. The contractor shall check the subgrade to insure proper thickness of sidewalk before depositing concrete.
- B. Stone Base- The stone base shall be compacted to eighty-five percent (85%) density by the use of a flat plate mechanical compactor. The Engineer may test compaction prior to concrete installation.

- C. Forms- The forms shall be either metal or wood and shall be straight, free from warp, of sufficient strength to resist springing during construction, and of a height equal to the full depth of the sidewalk to be constructed. Wood forms shall have a minimum normal thickness of two (2) inches. The forms shall be thoroughly cleaned, well oiled, securely staked, braced, and held to the required line and grade before any concrete is deposited. The minimum thickness of a sidewalk shall be four (4) inches. Where the sidewalk is used as a part of a driveway, it shall be at least six (6) inches thick. The Engineer may determine if additional thickness is required.

208.5 Depositing Concrete

The concrete shall be deposited between the forms on the rock base. The concrete shall be left somewhat higher and then struck off and compacted. It shall be tamped sufficiently to bring mortar to the top surface, and then finished with a wood float. The final surface texture of the sidewalk shall be obtained by a coarse brooming.

No retempering of concrete will be permitted. The walk shall have a slope toward the curb or street of not more than one-quarter ($\frac{1}{4}$) inch to the foot of width, or as otherwise shown on the plans.

Concrete placed when the temperature is below or expected to drop below forty degrees (40°) Fahrenheit shall be protected using insulated blankets or other methods. Concrete injured by frost action shall be removed and replaced at the contractor's expense.

Work not acceptable to the Engineer will be removed at no extra cost.

208.6 Joints

Contraction joints shall be cut three-quarter ($\frac{3}{4}$) inches in depth, with a suitable tooling device, and on five (5) foot intervals for residential, or seven (7) foot intervals for commercial sidewalks for the full width of the walk. Sawing of the joints will be permitted as an alternate. All joints are to be vertical and straight.

One-half ($\frac{1}{2}$) inch expansion joints of prepared material shall be provided at least every fifty (50) feet, and one-half ($\frac{1}{2}$) inch expansion joint material shall be used between the sidewalk ramp and curbing and around larger than four (4) inch castings or other obstructions, unless otherwise shown on the plans.

The edge of all joints and the edges of the sidewalk shall be rounded with an approved edging tool to one-quarter ($\frac{1}{4}$) inch radius. Care must be taken that the elevation of the slabs are the same on both sides of the joint.

208.7 Curb and Sidewalk Ramps

Ramps shall be constructed at all intersections and in areas where steps would occur. All ramps shall conform to the requirements of ADA, ADAAG, and ABA. The maximum slope of the

sidewalk shall be one to twelve (1:12). The surface texture of the ramp shall be obtained by a coarse brooming transverse to the slope of the ramp.

208.8 Detectable Warnings

Detectable warnings shall be installed where a sidewalk crosses a vehicular way, excluding unsignalized residential driveway crossings. The detectable warnings shall extend the full width of the depressed section of the ramp, starting at a distance of six (6) to eight (8) inches back from the bottom of the ramp, and extending a minimum of two (2) feet in the direction of the ramp. The detectable warnings shall be the color red or natural rust and one of the following types, installed in accordance with the manufacturer's recommendation:

NuWay Concrete Products: Pre-cast CAST IN TACT truncated dome panels.

East Jordan Iron Works: EJIW Series 7005 Detectable Warning Plates.

Neenah Foundry Company: Cast Iron Detectable Warning Plates.

208.9 Curing

Cure concrete according to 205.14.

208.10 Backfill

After the concrete has sufficiently set, the contractor shall remove the forms and shall backfill the space on each side of the walk. Backfill shall be compacted in a satisfactory manner. The contractor shall cut or fill each side of the sidewalk to the same elevation as the top of sidewalk.

208.11 Guarantee

The contractor shall guarantee his workmanship and materials against defects for two (2) years after the date of completion and acceptance thereof. If the contractor fails to remedy such defects within ten (10) days after the written notice to do so, the City has the right to repair the same or cause the same to be repaired and charge the cost of the same against this guarantee.

208.12 General Stipulations

It is understood that the work of construction shall be done under the direction and supervision of the City Engineer, subject to the approval by the Director of Public Works, and final acceptance of the City Council. Until work is accepted by the Engineer, it shall be in the custody and under the charge and care of the contractor. The contractor shall rebuild, repair, restore, or make good, at his expense, any lost or stolen City-owned material, and all injuries or damages to any portion of the work before its completion and acceptance, caused by the action of the elements or from any other reason. Issuance of a payment estimate on any part of the work done will not be considered a final acceptance of any work completed up to that time.

The contractor shall erect and maintain lights and barriers as required to protect the public

from injury during performance of the work and until it is finally received and will be held liable for any damage whatever to public or private interest suffered in consequence of the work.

Cleanout facilities shall be furnished as per Section 205.11(a).

The contractor shall remove all waste, debris, and surplus dirt from the site of the work, and leave the site in a neat and acceptable condition. All areas of disturbed earth shall be seeded and mulched with an acceptable material per the City's grading and stormwater ordinances.

These specifications are to replace all preceding or conflicting specifications regarding sidewalk construction.

PAGE LEFT BLANK INTENTIONALLY

SECTION 300

STANDARD DRAWINGS FOR STREET CONSTRUCTION AND DRIVEWAYS

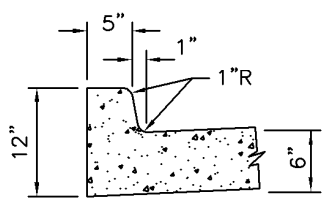
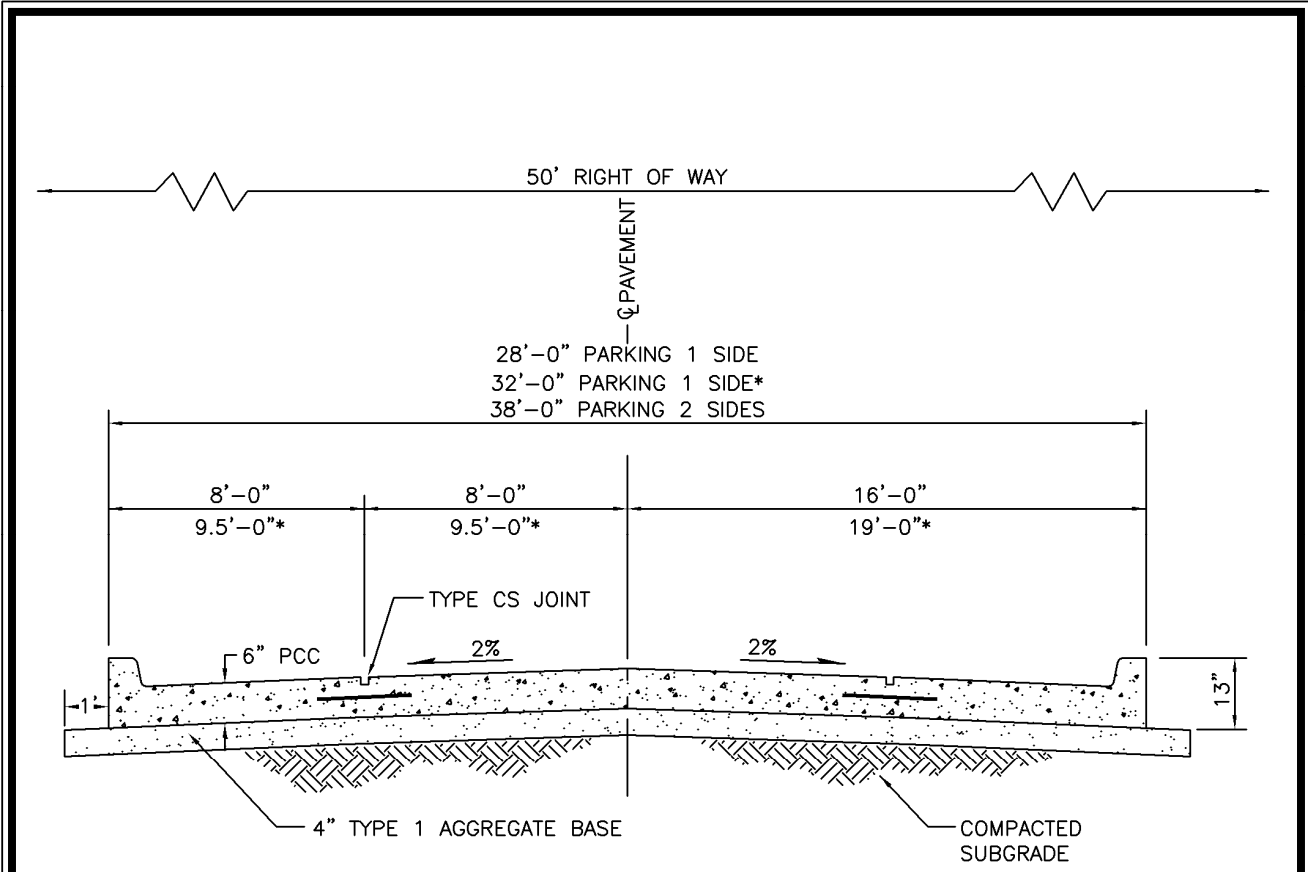

INTEGRAL UPRIGHT CURB SECTION

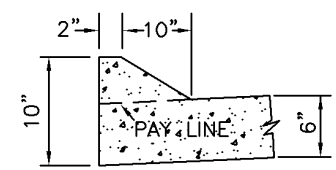

INTEGRAL LIP-TYPE CURB SECTION

NOTES:

1. ALL P.C. CONCRETE SHALL BE 28-DAY 4,000 PSI STRENGTH.
2. SEE "SAW CUT AND CONSTRUCTION JOINT" STANDARDS FOR DETAIL.
3. 32' STREET WITH PARKING ONE SIDE SHALL HAVE SIDEWALK ON ONE SIDE ONLY, ALL OTHERS SHALL HAVE SIDEWALKS ON BOTH SIDES.

DRAWING NO. 301	
K.A.P. Approved	03/31/11 Date
Revisions	

CITY OF JACKSON, MISSOURI

PORTLAND CEMENT CONCRETE STREET STANDARD
(RESIDENTIAL-LOCAL)

60' RIGHT OF WAY

CL PAVMNT

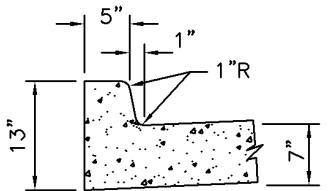
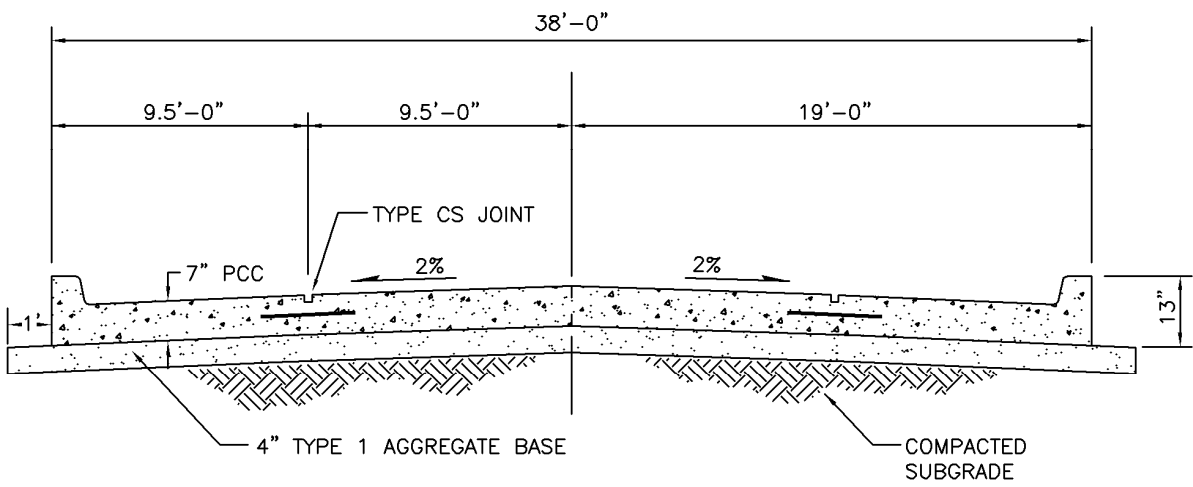

INTEGRAL UPRIGHT CURB SECTION
AT 2% CROSS SLOPE

STANDARD

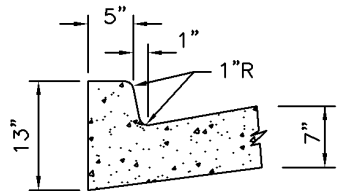

INTEGRAL UPRIGHT CURB SECTION
AT 6% CROSS SLOPE

AS REQUIRED BY ENGINEER

NOTES:

1. ALL P.C. CONCRETE SHALL BE 28-DAY 4,000 PSI STRENGTH.
2. SEE "SAW CUT AND CONSTRUCTION JOINT" STANDARDS FOR DETAIL.

DRAWING NO. 302	
K.A.P. Approved	03/31/11 Date
Revisions	

CITY OF JACKSON, MISSOURI

PORTLAND CEMENT CONCRETE STREET STANDARD
(COLLECTOR)

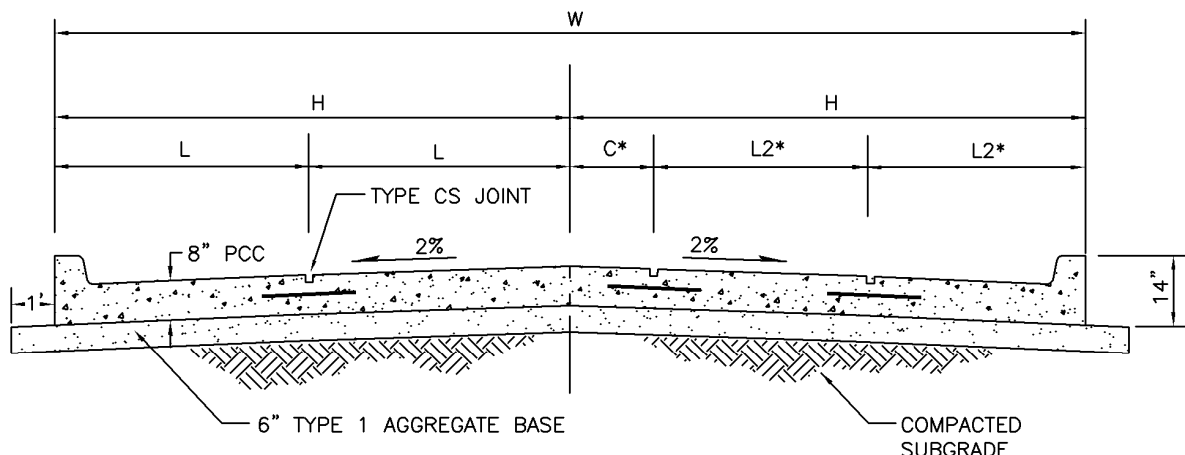
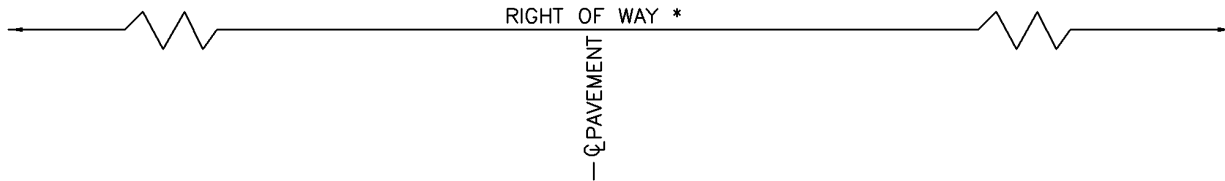

LANES	2	4	5
ROW	64'	80'	100'
W	42'	50'	64'
H	21'	25'	32'
L	10.5'	12.5'	
L2*			13'
C*			6'

*DIMENSION FOR 5-LANE STREET

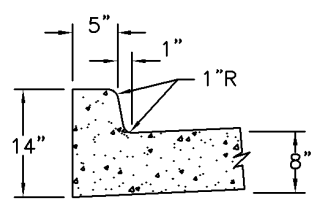

INTEGRAL UPRIGHT CURB SECTION

NOTES:

1. ALL P.C. CONCRETE SHALL BE 28-DAY 4,000 PSI STRENGTH.
2. SEE "SAW CUT AND CONSTRUCTION JOINT" STANDARDS FOR DETAIL.

DRAWING NO. 303	CITY OF JACKSON, MISSOURI										
<table border="1"> <tr> <td>K.A.P.</td> <td>03/31/11</td> </tr> <tr> <td>Approved</td> <td>Date</td> </tr> <tr> <td colspan="2">Revisions</td> </tr> <tr> <td> </td> <td> </td> </tr> <tr> <td> </td> <td> </td> </tr> </table>	K.A.P.	03/31/11	Approved	Date	Revisions						<p>PORTLAND CEMENT CONCRETE STREET STANDARD (COMMERCIAL-ARTERIAL)</p>
K.A.P.	03/31/11										
Approved	Date										
Revisions											

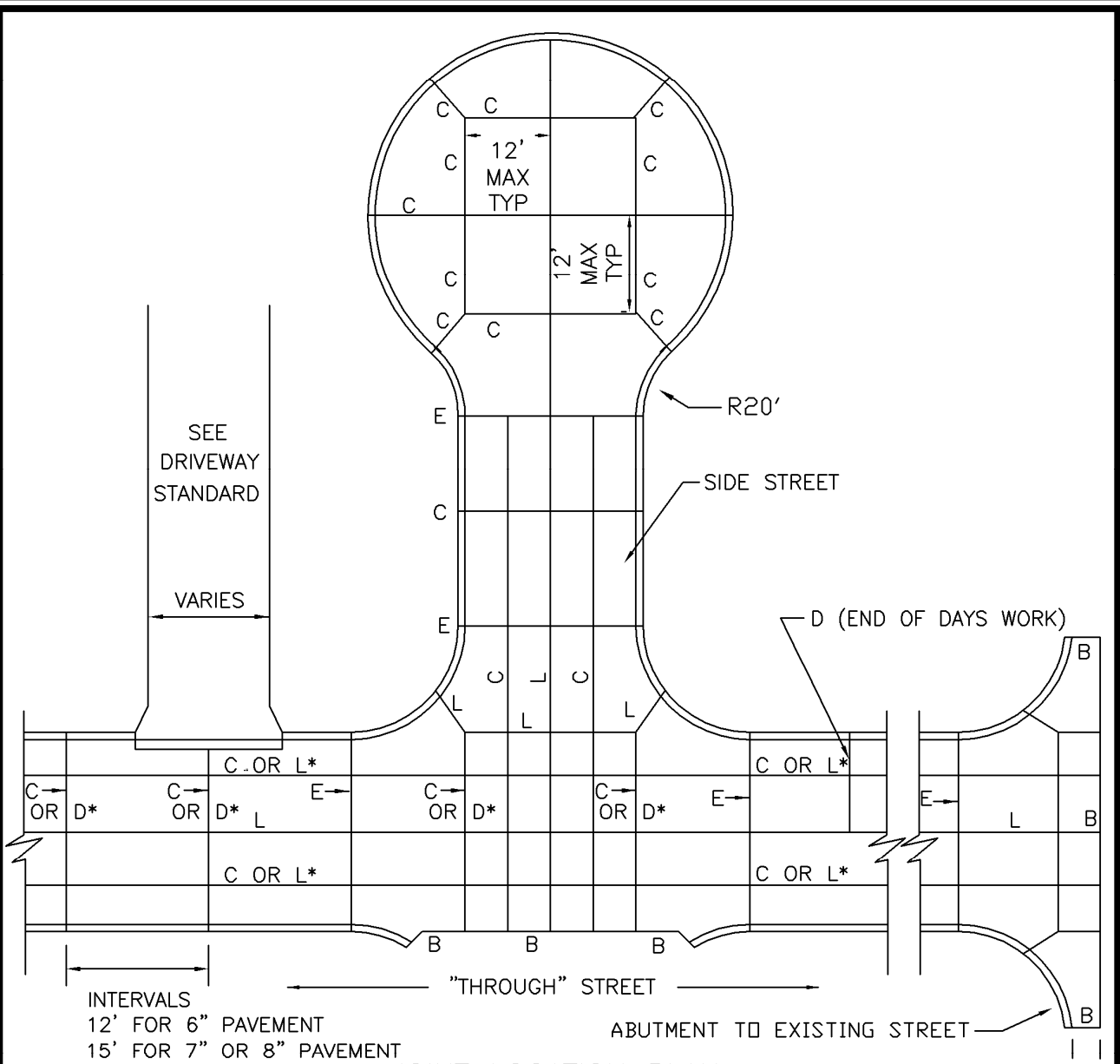

NOTES:

1. TRANSVERSE TYPE C AND D JOINTS SHALL BE SAWED AS SOON AS CONCRETE CAN WITHSTAND RAVELING, JOINTS SHALL BE CLEANED AND FILLED WITH BITUMINOUS COMPOUND.
2. INSTALL TYPE E EXPANSION JOINTS AT INTERSECTIONS, AND AT END OF RADIUS'S AND AT BULB OF CUL-DE-SAC.
3. INSTALL TYPE E REINFORCED EXPANSION JOINTS AT PC & PT OF CURVES.
4. USE TYPE D JOINT AT END OF DAYS WORK AND PAVEMENTS GREATER THAN 6-INCHES.
5. USE TYPE L JOINT FOR PAVEMENTS GREATER THAN 6-INCHES.

DRAWING NO. 304	
K.A.P.	03/31/11
Approved	Date
Revisions	

CITY OF JACKSON, MISSOURI

PORTLAND CEMENT CONCRETE STREET STANDARD

SAW CUT DETAILS

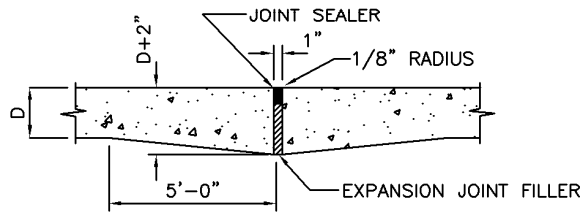

TYPE A
EXPANSION JOINT OR PAVEMENT TERMINATION

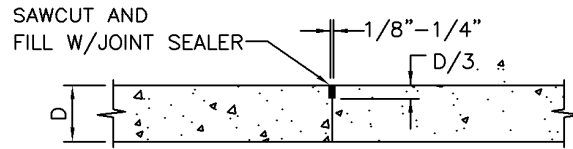

TYPE C (WITHOUT TIE BAR)
CONTRACTION JOINT

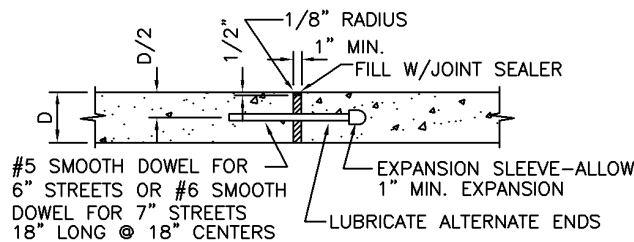

BAR SUPPORT ASSEMBLIES OR CHAIRS REQUIRED

TYPE E
REINFORCED EXPANSION JOINT

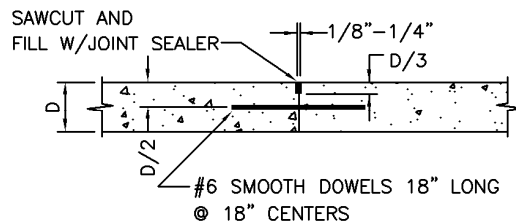

BAR SUPPORT ASSEMBLIES OR CHAIRS
LUBRICATE ALTERNATE ENDS OF DOWELS

TYPE D (STREETS 7" AND GREATER)
REINFORCED CONTRACTION JOINT

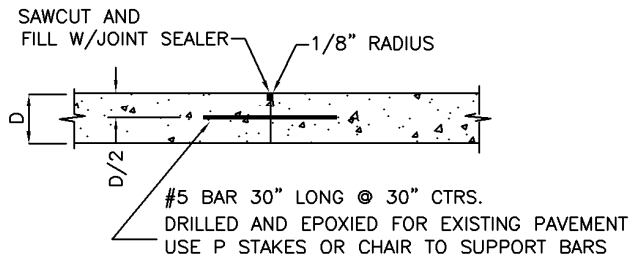

TYPE L
LONGITUDINAL CONSTRUCTION JOINT
(With Steel)

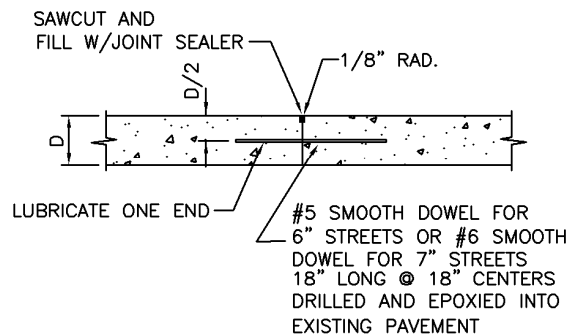

TYPE B
TRANSVERSE CONSTRUCTION JOINT

NOTES:

1. CITY OF JACKSON "STANDARD SPECIFICATIONS FOR STREET IMPROVEMENTS 2009" SHALL APPLY.
2. EXPANSION JOINTS ARE PLACED AT APPROXIMATELY 250 FOOT INTERVALS OR AS DIRECTED BY THE CITY ENGINEER.
3. SAW CUT DEPTH SHALL BE ONE THIRD OF PAVEMENT THICKNESS
4. ALL STEEL MUST BE SECURELY SUPPORTED TO BE POSITIONED AS SPECIFIED.

DRAWING NO. 305

CITY OF JACKSON, MISSOURI

K.A.P. 03/31/11
Approved Date

PORTLAND CEMENT CONCRETE STREET STANDARD

Revisions

EXPANSION / CONSTRUCTION JOINT DETAILS

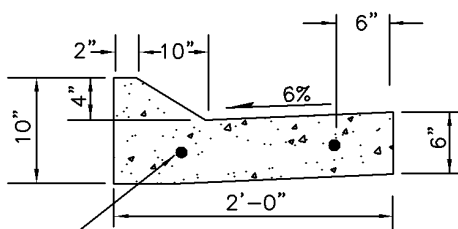
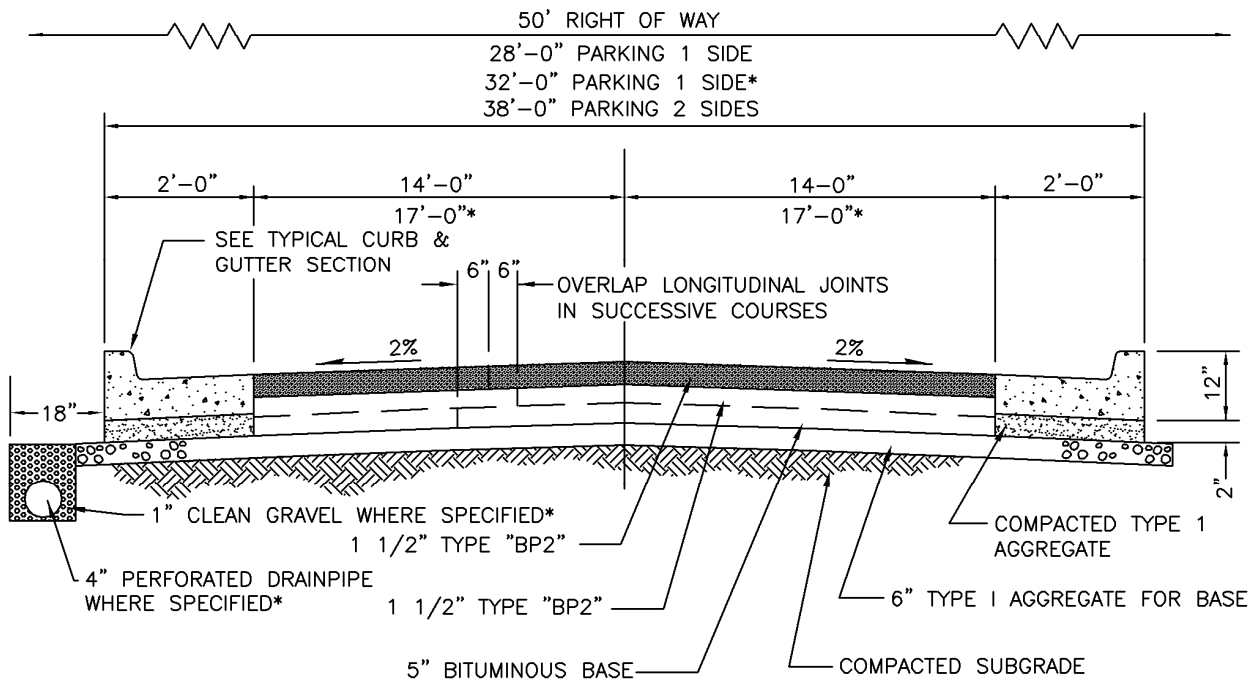

LIP CURB AND GUTTER SECTION

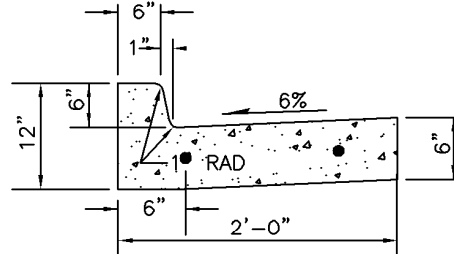

UPRIGHT CURB AND GUTTER SECTION

NOTES:

1. MISSOURI STANDARD SPECIFICATIONS FOR HIGHWAY CONSTRUCTION 2004 SHALL APPLY PER SECTION 403: ASPHALTIC CONCRETE PAVEMENT
2. ALL P.C. CONCRETE SHALL BE 28-DAY, 4000 PSI STRENGTH.
3. INSTALL 1" TYPE "A" EXPANSION JOINTS IN CURB AND GUTTER SECTION AT P.C. AND P.T. OF CURB RADIUS OF INTERSECTIONS.
4. INSTALL SAW JOINTS IN CURB AND GUTTER SECTION AT 12 FT. MAXIMUM SPACING, SEAL WITH BITUMINUS JOINT SEALANT.
5. EDGE DRAINS SHOWN FOR EXAMPLE AND CLARITY, ONLY TO BE INSTALLED WHERE SPECIFIED. MAY BE SPECIFIED FOR CONCRETE OR ASPHALT STREETS WHERE NEEDED.
6. 32' STREET WITH PARKING ONE SIDE SHALL HAVE SIDEWALK ON ONE SIDE ONLY, ALL OTHERS SHALL HAVE SIDEWALKS ON BOTH SIDES.

DRAWING NO. 306	CITY OF JACKSON, MISSOURI								
<table border="1" style="width: 100%; border-collapse: collapse;"> <tr> <td style="width: 50%; padding: 2px;">K.A.P.</td> <td style="width: 50%; padding: 2px;">03/31/11</td> </tr> <tr> <td style="padding: 2px;">Approved</td> <td style="padding: 2px;">Date</td> </tr> <tr> <td colspan="2" style="padding: 2px;">Revisions</td> </tr> <tr> <td colspan="2" style="padding: 2px;"> </td> </tr> </table>	K.A.P.	03/31/11	Approved	Date	Revisions				ASPHALTIC CONCRETE STREET STANDARD (LOCAL-RESIDENTIAL)
K.A.P.	03/31/11								
Approved	Date								
Revisions									

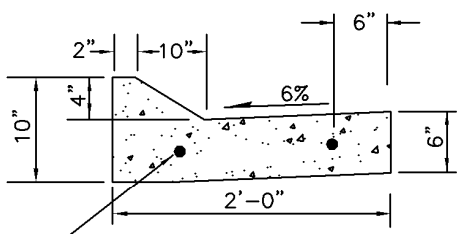
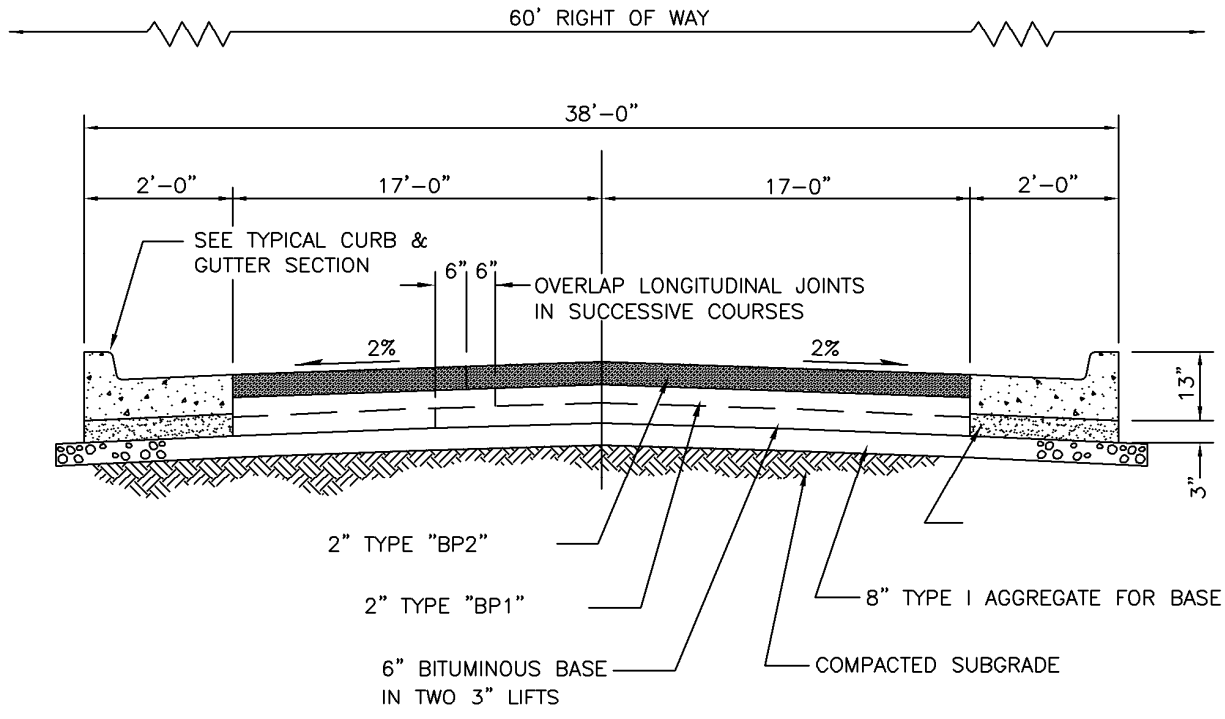

TYPE E EXPANSION JOINTS @ 75' INTERVALS #5 DOWELS; 18" LONG

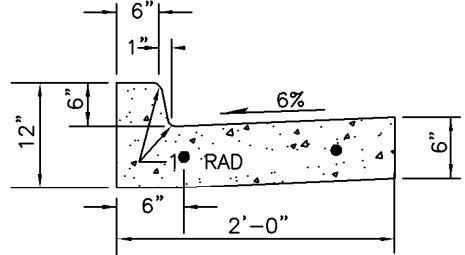

UPRIGHT CURB AND GUTTER SECTION

NOTES:

1. MISSOURI STANDARD SPECIFICATIONS FOR HIGHWAY CONSTRUCTION 2004 SHALL APPLY PER SECTION 403: ASPHALTIC CONCRETE PAVEMENT
2. ALL P.C. CONCRETE SHALL BE 28-DAY, 4000 PSI STRENGTH.
3. INSTALL 1" TYPE "A" EXPANSION JOINTS IN CURB AND GUTTER SECTION AT P.C. AND P.T. OF CURB RADIUS OF INTERSECTIONS.
4. INSTALL SAW JOINTS IN CURB AND GUTTER SECTION AT 15 FT. MAXIMUM SPACING, SEAL WITH BITUMASTIC JOINT SEALANT.

DRAWING NO. 307	CITY OF JACKSON, MISSOURI								
<table style="width: 100%; border-collapse: collapse;"> <tr> <td style="width: 50%; border-bottom: 1px solid black;">K.A.P. <small>Approved</small></td> <td style="width: 50%; border-bottom: 1px solid black;">03/31/11 <small>Date</small></td> </tr> <tr> <td colspan="2" style="border-bottom: 1px solid black;">Revisions</td> </tr> <tr> <td colspan="2" style="border-bottom: 1px solid black;"> </td> </tr> <tr> <td colspan="2"> </td> </tr> </table>	K.A.P. <small>Approved</small>	03/31/11 <small>Date</small>	Revisions						ASPHALTIC CONCRETE STREET STANDARD (COLLECTOR)
K.A.P. <small>Approved</small>	03/31/11 <small>Date</small>								
Revisions									

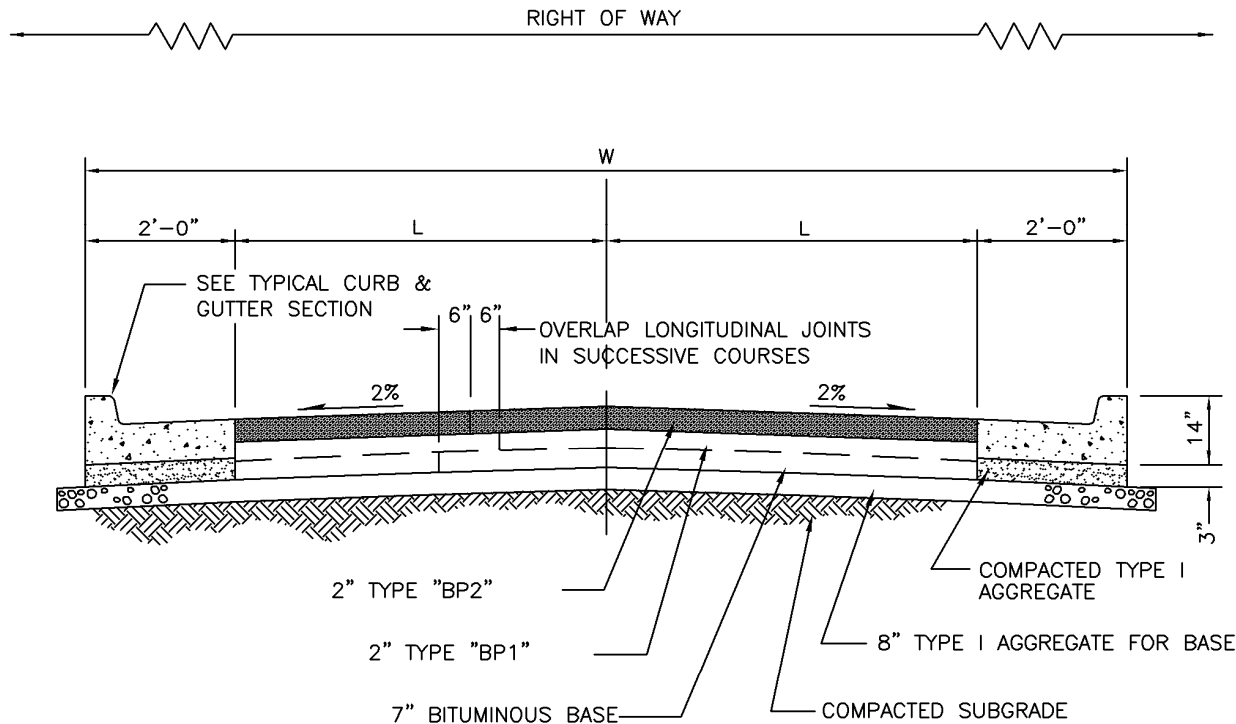

LANES	2	4	5
ROW	64'	80'	100'
W	42'	50'	64'
L	19'	23'	30'

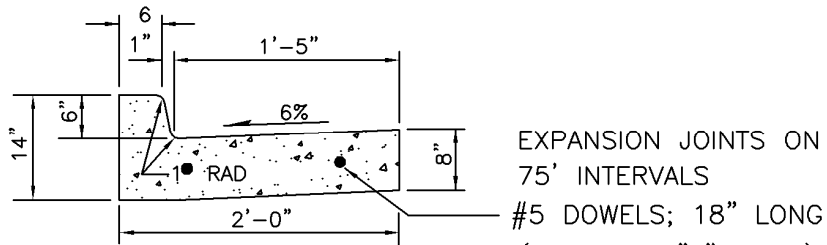

TYPICAL CURB AND GUTTER SECTION

NOTES:

1. MISSOURI STANDARD SPECIFICATIONS FOR HIGHWAY CONSTRUCTION 2004 SHALL APPLY PER SECTION 403: ASPHALTIC CONCRETE PAVEMENT
2. ALL P.C. CONCRETE SHALL BE 28-DAY, 4000 PSI STRENGTH.
3. INSTALL 1" TYPE "A" EXPANSION JOINTS IN CURB AND GUTTER SECTION AT P.C. AND P.T. OF CURB RADIUS OF INTERSECTIONS.
4. INSTALL SAW JOINTS IN CURB AND GUTTER SECTION AT 15 FT. MAXIMUM SPACING, SEAL WITH BITUMASTIC JOINT SEALANT.

DRAWING NO. 308	CITY OF JACKSON, MISSOURI						
<table border="1" style="width: 100%; border-collapse: collapse;"> <tr> <td style="width: 50%; padding: 2px;">K.A.P. Approved</td> <td style="width: 50%; padding: 2px;">03/31/11 Date</td> </tr> <tr> <td colspan="2" style="padding: 2px;">Revisions</td> </tr> <tr> <td colspan="2" style="padding: 2px;"> </td> </tr> </table>	K.A.P. Approved	03/31/11 Date	Revisions				ASPHALTIC CONCRETE STREET STANDARD (COMMERCIAL-ARTERIAL)
K.A.P. Approved	03/31/11 Date						
Revisions							

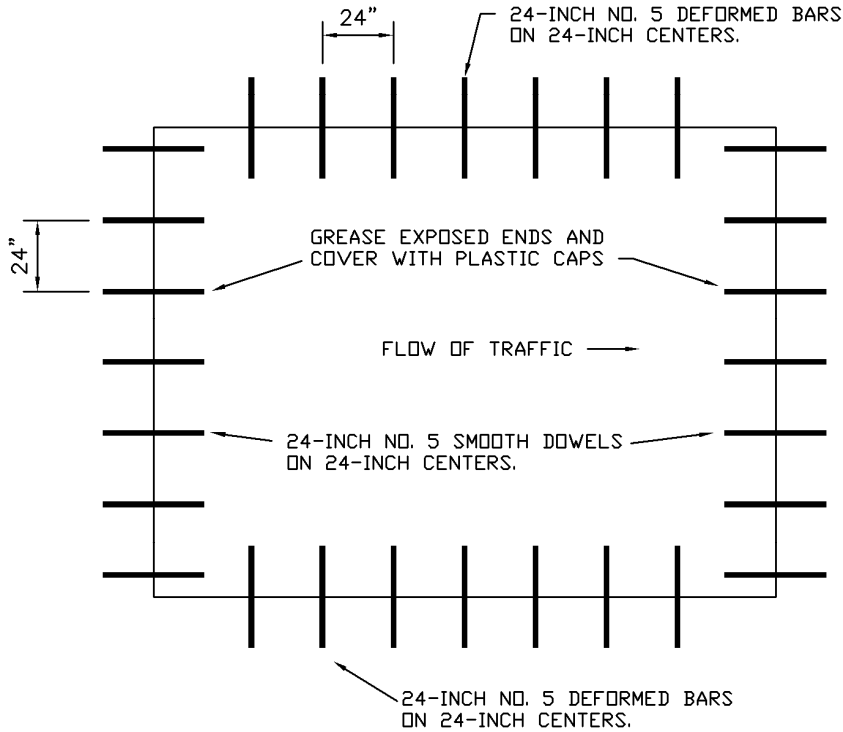

CONCRETE STREET PATCH JOINT DETAIL
NOT TO SCALE

- NOTES:
- 1) ALL CONCRETE STREET PATCHES MUST BE 1-INCH THICKER THAN EXISTING PAVEMENT.
 - 2) NO LESS THAN 1/2 PANEL SHALL BE REPLACED.
 - 3) EDGE OF TRENCH SHALL BE AT LEAST 2- FEET FROM EDGE OF PANEL.
 - 4) MUST NOT DISTURB SUBGRADE UNDER ADJOINING PANELS.
 - 5) MINIMUM 4-INCHES COMPACTED GRANULAR BASE PLACED ON COMPACTED SUBGRADE PER STANDARD STREET SPECIFICATIONS.

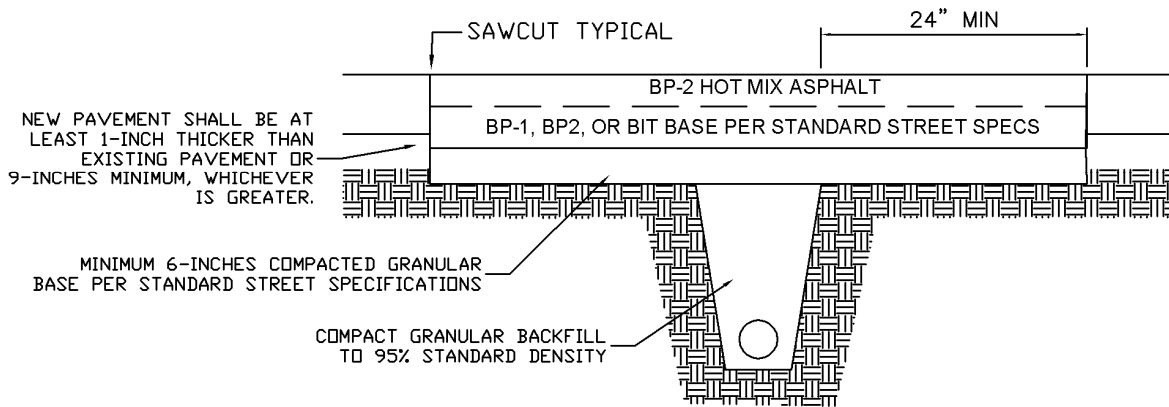

FLEXIBLE PAVEMENT STREET PATCH DETAIL
NOT TO SCALE

DRAWING NO. 309

CITY OF JACKSON, MISSOURI

K.A.P. 03/31/11
 Approved Date

Revisions

STREET PATCH DETAIL

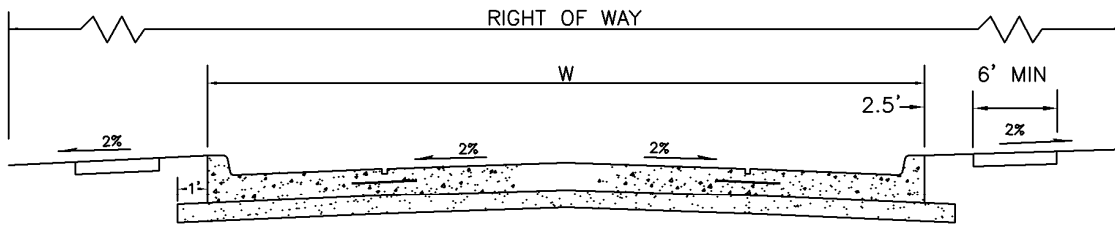

COMMERCIAL-ARTERIAL

LANES	2	4	5
ROW	64'	80'	100'
W	42'	50'	64'

NO PARKING EITHER SIDE

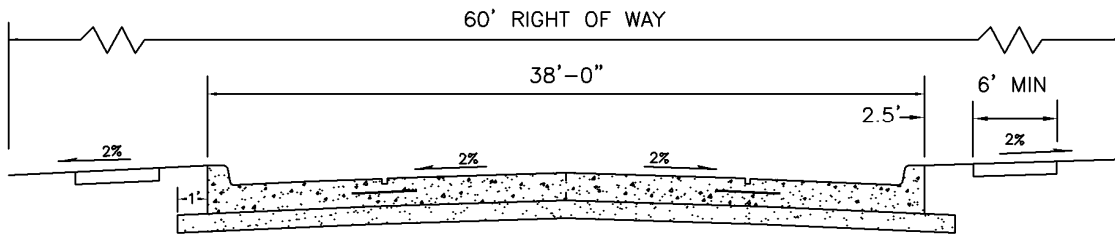

COLLECTOR

NO PARKING EITHER SIDE

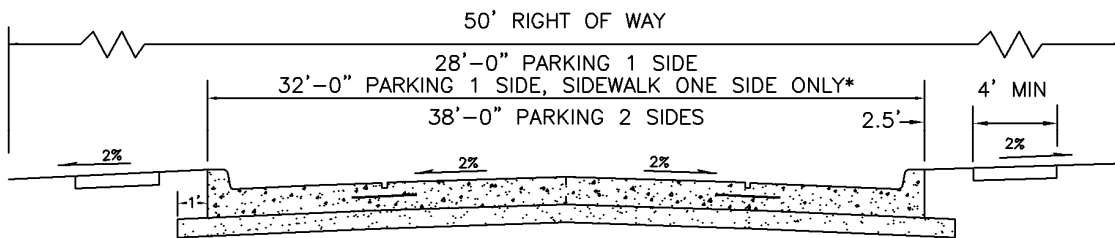

RESIDENTIAL-LOCAL

NOTE: ALL OTHERS SHALL HAVE SIDEWALKS ON BOTH SIDES

DRAWING NO. 310	CITY OF JACKSON, MISSOURI										
<table border="1" style="width: 100%;"> <tr> <td style="width: 70%;">K.A.P.</td> <td style="width: 30%;">03/31/11</td> </tr> <tr> <td>Approved</td> <td>Date</td> </tr> <tr> <td colspan="2">Revisions</td> </tr> <tr> <td> </td> <td> </td> </tr> <tr> <td> </td> <td> </td> </tr> </table>	K.A.P.	03/31/11	Approved	Date	Revisions						STREET AND RIGHT OF WAY STANDARD WIDTHS
K.A.P.	03/31/11										
Approved	Date										
Revisions											

MINIMUM 15" DIA. CULVERT,
MIN. 10' FROM CURB,
OUTSIDE R.O.W

36' MAXIMUM
A

RIGHT OF WAY

DRIVEWAY WINGOUT OR
RADIUS PERMITTED.

PROPOSED DRIVEWAY

#5 DIA. X 24" LONG DEFORMED
BARS AT 24" CENTERS
EPOXIED IN EXISTING PAVEMENT

TAPERED CURB
BACK OF CURB

1" EXPANSION JOINT

DRIVEWAY CURB AND GUTTER SECTION

PLAN
A

6" P.C.C.
4000 PSI
WITHIN ROW

MAXIMUM 2% GRADE ON R.O.W.

PROPOSED DRIVEWAY

10" P.C.C.

1" EXPANSION JOINT
(2" ON OUTSIDE OF CURVES)

1" THICKER
THAN EXISTING
PAVEMENT

EXISTING PAVEMENT
APPROVED EPOXY

SEE
NOTE
#13

R.O.W.

5'-0"
THICKENED EDGE.

2'-0"
CURB SECTION

NOTES:

SECTION A-A

1. CONCRETE AND JOINTS TO BE PLACED IN ACCORDANCE WITH STANDARD SPECIFICATIONS FOR STREET IMPROVEMENTS FOR THE CITY OF JACKSON, MISSOURI.
2. DRIVEWAY WIDTH AND RADIUS TO BE PLACED AS SPECIFIED BY JACKSON CITY CODE OF ORDINANCES.
3. TAPER END OF CURB AS DIRECTED TO MATCH NEW DRIVEWAY.
4. SAW PAVEMENT JOINTS TO A 3.5" MINIMUM DEPTH.
5. SAW PAVEMENT TO TO BE REMOVED FULL DEPTH.
6. PLACE DEFORMED BARS 1/2 DEPTH OF PAVEMENT.
7. SHADED AREA DENOTES CURB AND GUTTER TO BE REMOVED AND REPLACED 1" THICKER THAN EXISTING PAVEMENT.
8. A SIX (6) INCH CURB SHALL NOT BE DEPRESSED OVER FOUR AND ONE HALF (4 1/2) INCHES.
9. NO GRAVEL DRIVEWAYS (NEW) ARE ALLOWED ON CITY RIGHT OF WAY.
10. ON RESIDENTIAL DRIVES A RADIUS OR WING MAY BE CONSTRUCTED.
11. NO DRIVEWAY CURBS ARE ALLOWED ON CITY RIGHT OF WAY.
12. MAXIMUM 2% GRADE ON R.O.W., THEN 15% MAXIMUM GRADE RESIDENTIAL, 10% COMMERCIAL AND INDUSTRIAL.
13. DRIVEWAY CULVERTS SHALL BE 15" MINIMUM AND APPROVED BY CITY ENGINEER, LOCATED MINIMUM 10' FROM CURB, AND OUTSIDE RIGHT OF WAY UNLESS OTHERWISE APPROVED.

DRAWING NO. 311

CITY OF JACKSON, MISSOURI

K.A.P. 03/31/11
Approved Date

DRIVEWAY PLAN AND

Revisions

DRIVEWAY CURB AND GUTTER SECTION

D/W GRADE ON RIGHT OF WAY:
 2% OR 1/4" PER FOOT
 MAXIMUM DRIVEWAY GRADE
 15% RESIDENTIAL, 10% COMMERCIAL AND INDUSTRIAL

CITY STREET

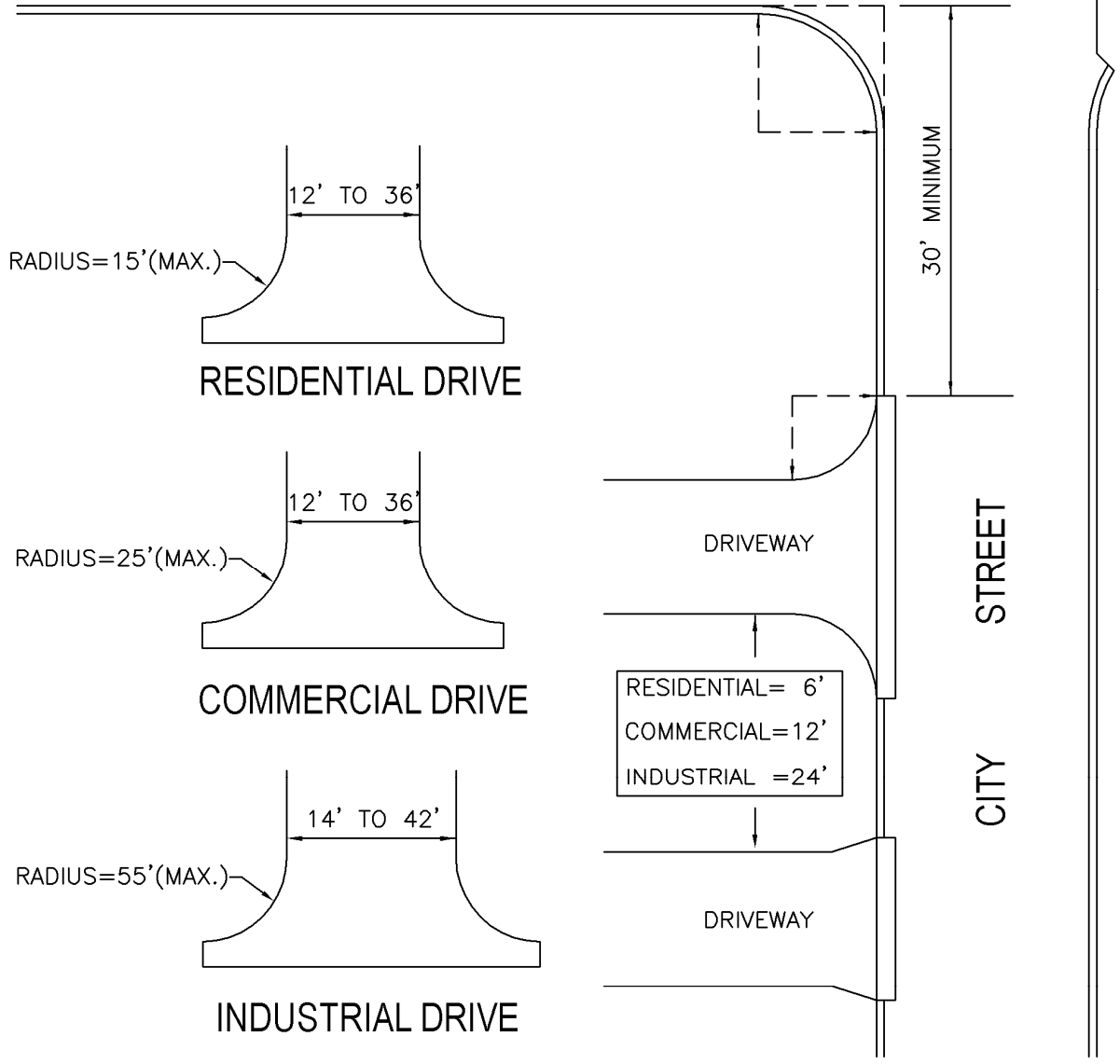

DRAWING NO. 312

JACKSON, MISSOURI

DRIVEWAY STANDARDS

K.A.P.	02/20/09
Approved	Date
Revisions	

DESIGN CRITERIA	RESIDENTIAL	COMMERCIAL	INDUSTRIAL
Width at End of Radius	12' - 36"	12' - 36'	14' - 42'
Radius	Maximum 15'	Maximum 25'	Maximum 55'
Grade on Right-of-Way	1/4" Per Foot	1/4" Per Foot	1/4" Per Foot
Maximum Driveway Grade	15%	10%	10%
Spacing Between the Ends of radii at the Curbline	6'	12'	24'
<p>Corner Clearance (In no case to be less than 30' as measured from the intersection of the tangent lines of the corner radius.)</p>			

DRAWING NO. 313.

CITY OF JACKSON, MISSOURI

K.A.P. 02/20/09
 Approved Date

DRIVEWAY DESIGN

Revisions

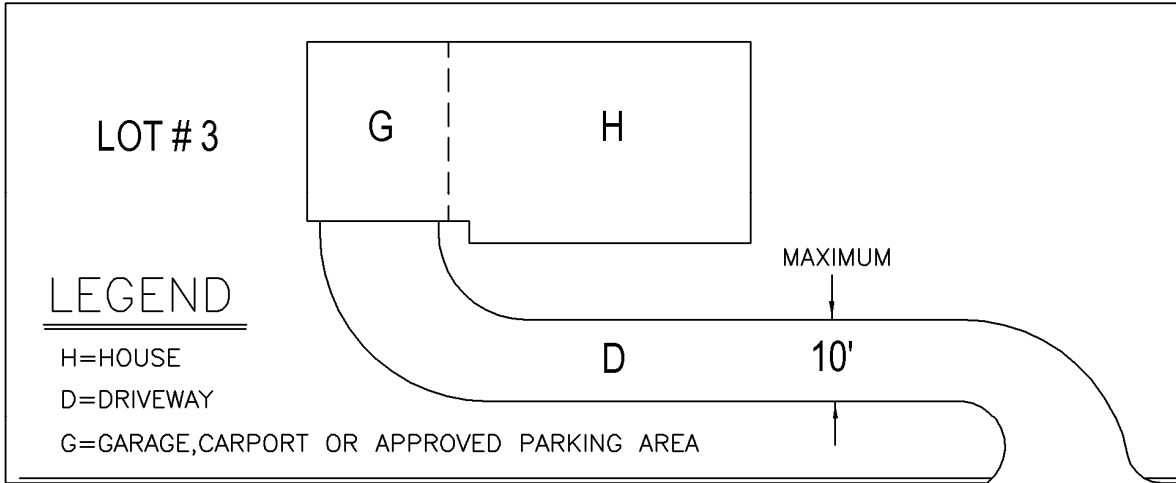
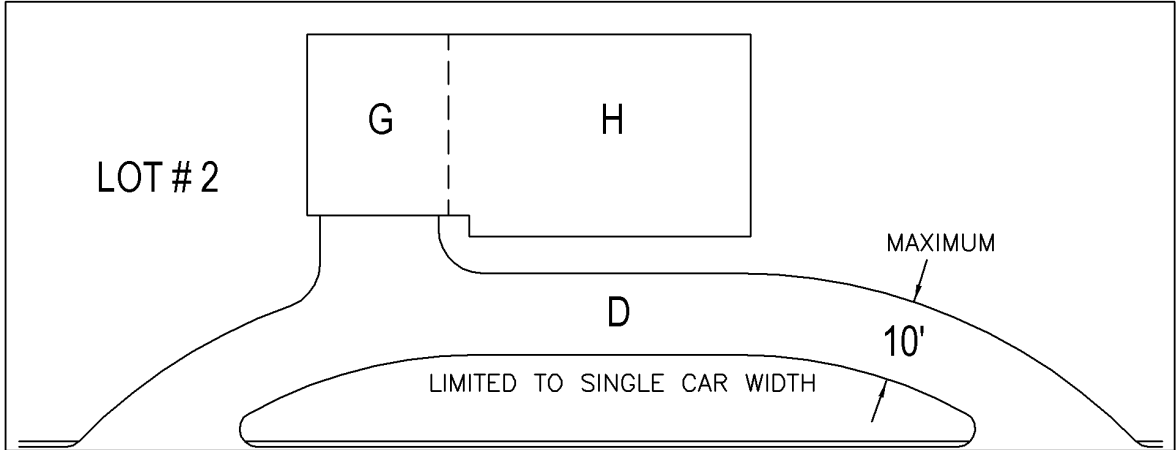
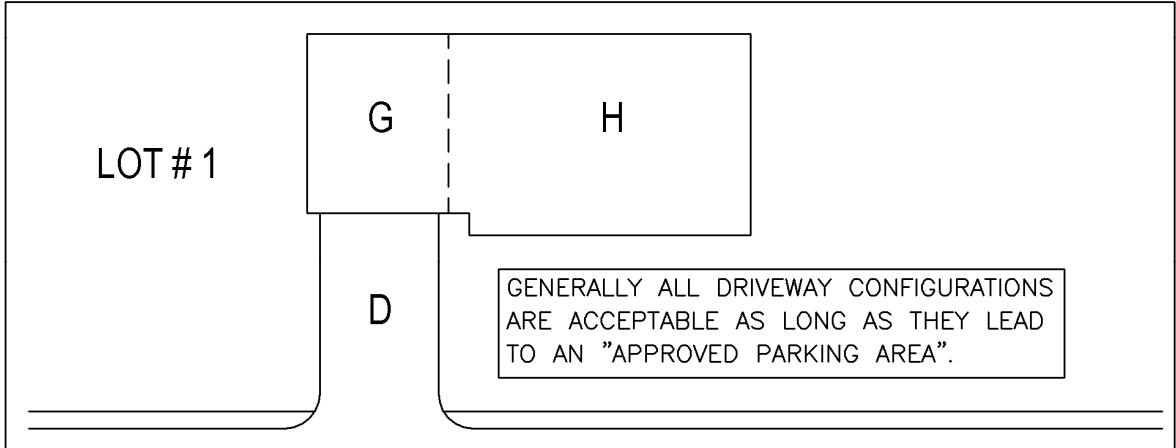

DRAWING NO. 314

CITY OF JACKSON, MISSOURI

K.A.P. 02/20/09
Approved Date

Revisions

POSSIBLE DRIVEWAY CONFIGURATIONS

CURB RAMP STANDARD

CONSTRUCTION NOTES:

1. ALL CONSTRUCTION SHALL BE IN ACCORDANCE WITH APPLICABLE SECTIONS OF THE CURRENT STANDARD SPECIFICATIONS FOR STREET IMPROVEMENTS FOR THE CITY OF JACKSON, MO.
2. CURB AND GUTTER REPLACEMENT SHALL BE PER DRAWING NO. 311 OF THE STANDARD SPECIFICATIONS FOR STREET IMPROVEMENTS.
3. CONTRACTION JOINTS SHALL BE CUT 3/4" DEEP WITH PROPER TOOL, OR SAWED VERTICAL AND STRAIGHT.
4. EXPANSION JOINTS OF 1/2" PREFORMED MATERIAL SHALL BE PROVIDED EVERY 20 TO 30 FEET. EXPANSION MATERIAL OF 1/2" SHALL BE USED BETWEEN THE SIDEWALK RAMP AND CURBING AND AROUND CASTINGS LARGER THAN 4" DIAMETER OR OTHER OBSTRUCTIONS, UNLESS OTHERWISE SHOWN ON THE PLANS.
5. SIDEWALK WIDTH SHALL BE 4 FEET IN RESIDENTIAL AREAS AND 6 FEET IN COMMERCIAL AREAS.
6. MINIMUM SIDEWALK THICKNESS SHALL BE 4 INCHES. DRIVEWAY CROSSINGS AND CURB RAMPS SHALL BE 6 INCHES THICK.
7. ALL CURB RAMPS ARE REQUIRED TO HAVE AT LEAST TWO SPECIFIC WARNINGS: TRUNCATED DOMES AND COLORING.

PLAN VIEW
SINGLE DOWN SET RAMP
SIDEWALK ABUTTING CURB

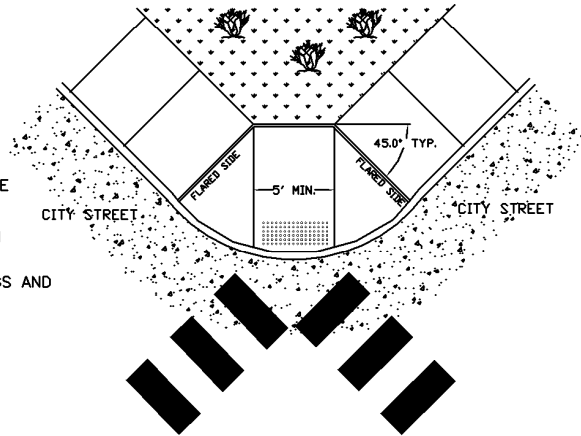

ELEVATION VIEW
SINGLE DOWN SET RAMP - MIDDLE OF CURB



PLAN VIEW
SINGLE DOWN SET RAMP
SIDEWALK OFFSET FROM CURB

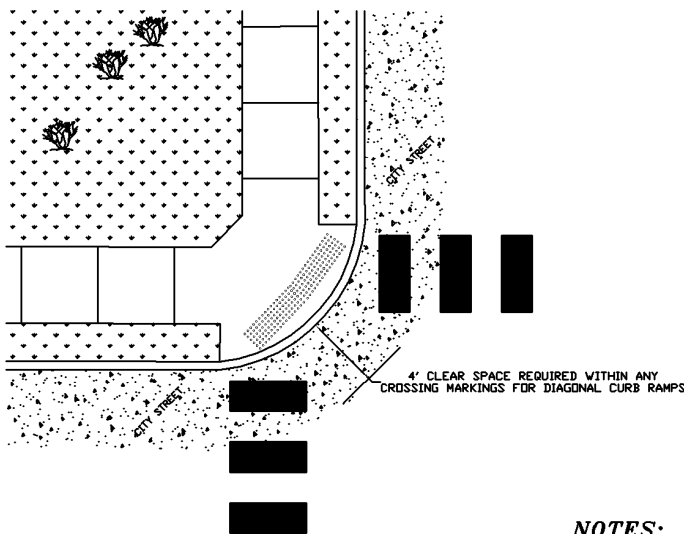

NOTES:

1. THE MAXIMUM SLOPE OF THE SIDEWALK SHALL BE 1:12.
2. RAMPS SHALL HAVE DETECTABLE WARNINGS EXTENDING THE FULL WIDTH AND DEPTH OF THE CURB.
3. THE CURB AND GUTTER SECTION SHALL BE CONSIDERED AS PART OF THE RAMP CONSTRUCTION.

DRAWING NO. 315

CITY OF JACKSON, MISSOURI

K.A.P. 02/20/09
Approved Date

Revisions

SIDEWALK AND RAMP STANDARDS

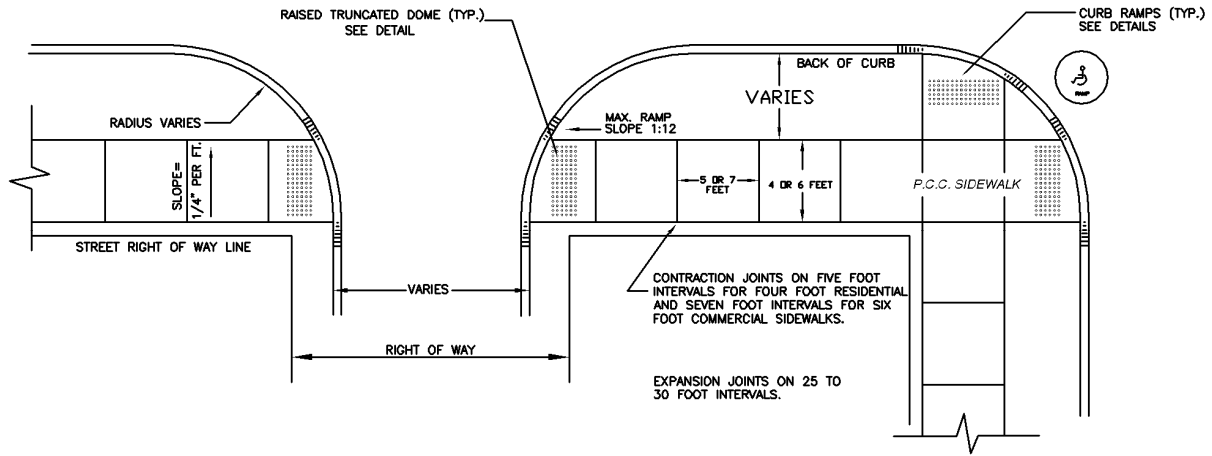

NOTE: SLOPE SIDEWALK 1/4" PER FOOT TOWARD STREET

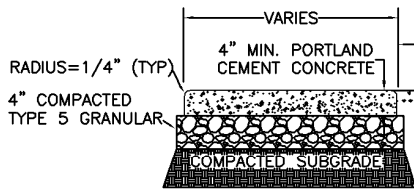

CROSS SECTIONAL VIEW
NTS

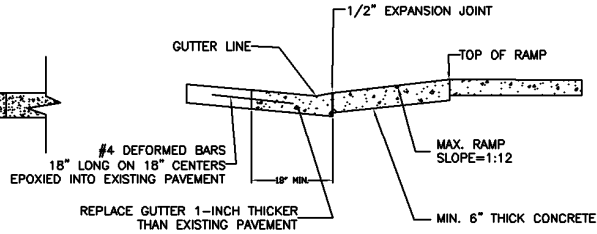

TYPICAL PROFILE
NTS

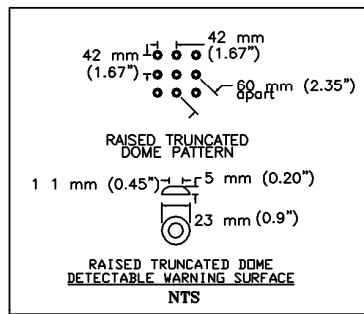

SIDEWALK & RAMP STANDARDS

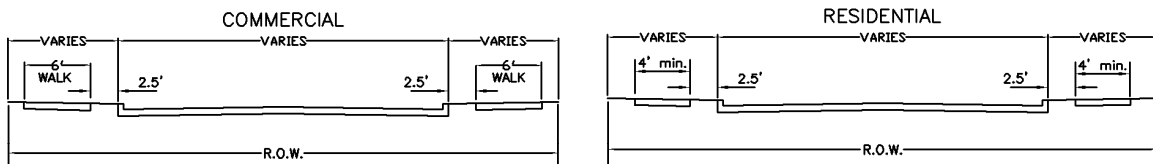

DRAWING NO. 316

CITY OF JACKSON, MISSOURI

K.A.P. 04/01/11
Approved Date

Revisions

SIDEWALK AND RAMP STANDARDS

NOTES:

1. CURB RAMPS SHALL BE PROVIDED TO ALLOW ALL USERS TO MAKE THE TRANSITION IN GRADE FROM THE STREET TO THE SIDEWALK.
2. CURB RAMPS SHALL BE CONSTRUCTED TO THE DIMENSIONS AND FINISHED ELEVATIONS AS SPECIFIED IN THE PLANS AND/OR CONTRACT DOCUMENTS AND SHALL ALSO CONFORM TO THE REQUIREMENTS OF THE AMERICANS WITH DISABILITIES ACT. SURFACE TEXTURE OF THE CURB RAMP SHALL BE STABLE, FIRM, AND SLIP-RESISTANT. THE SURFACE SHALL BE COARSE BROOMED FINISH TRANSVERSE TO THE SLOPE OF THE RAMP. CARE SHALL BE TAKEN TO ASSURE AN UNIFORM GRADE ON THE CURB RAMP. LONGITUDINAL AND TRANSVERSE JOINT MARKINGS SHALL NOT BE ALLOWED ON THE LANDINGS OR RAMPS.
3. DETECTABLE WARNINGS (I.E. TRUNCATED DOMES) SHALL BE INSTALLED WHERE A SIDEWALK CROSSES A VEHICULAR WAY, EXCLUDING UNSIGNALIZED DRIVEWAY CROSSINGS. CAST IN PLACE, OR STAMPED DOMES SHALL NOT BE ACCEPTABLE.
4. DRAINAGE AND UTILITY STRUCTURES SHALL NOT BE PLACED IN CURB RAMP OR LANDING.
5. THE GUTTER LINE PROFILE OF THE STREET SHALL BE MAINTAINED THROUGH THE AREA OF THE CURB RAMP.
6. THE PARKWAY BUFFERS PEDESTRIANS FROM THE ADJACENT ROADWAY, AND IS ALSO THE AREA WHERE ELEMENTS SUCH AS STREET TREES, SIGNAL POLES, UTILITY POLES, STREET LIGHTS, CONTROLLER BOXES, HYDRANTS, SIGNS, PARKING METERS, DRIVEWAY APRONS, GRATES, HATCH COVERS, AND STREET FURNITURE ARE PROPERLY LOCATED.
7. DRAWINGS SHOWN HEREIN REPRESENT MINIMUM STANDARDS. ALL SIDEWALKS AND APPURTENANCES SHALL BE COMPLIANT WITH 28 CFR PART 36 AND ALL APPLICABLE STANDARDS OF THE AMERICANS WITH DISABILITIES ACT (ADA).

DRAWING NO. 317	CITY OF JACKSON, MISSOURI
K.A.P. <u>04/01/11</u> Approved Date Revisions	SIDEWALK AND RAMP STANDARDS